



**KOLEDARJI
ROKOVNIKI
OSTALI
PROMOCIJSKI
IZDELKI**

3

SUPERIOR

(JM) Ponudba koledarjev višje kakovosti

29

STANDARD

(F) Klasični koledarji in promocijski izdelki

72

PREMIUM

(E) Klasični koledarji in usnjeni rokavniki

101

KLASIK

(M) Namizni koledarji, rokavniki, etuiji

SUPERIOR

Ponudba koledarjev višje kakovosti



T: 08 385 04 84
08 385 04 81

M: 040 861 890

E: info@partnergraf.si
prodaja@partnergraf.si

W: www.partnergraf.si

PARTNER GRAF zelena tiskarna d.o.o.
Gasilska cesta 3, SI - 1290 Grosuplje



LOGO 330 X 60 MM



LOGO 330 X 60 MM



SLOVENIJA



dimenzija mm

330 X 540

št. listov

13

VPC brez ddv

3,89 €

šifra

201219

pakirano

25 kos/karton
+ PRILožENE NAT. VREČKE

• SLO
IMENA

ROMANTIČNA SLOVENIJA



LOGO 330 X 60 MM



LOGO 330 X 60 MM



dimenzija mm

330 X 540

št. listov

13

VPC brez ddv

4,39 €

šifra

201271

pakirano

25 kos/karton
+ PRILožENE NAT. VREČKE

• SLO
IMENA

LEPA SLOVENIJA



LOGO 225 X 60 MM



LOGO 225 X 60 MM



dimenzija mm

230 X 540

št. listov

13

VPC brez ddv

3,79 €

šifra

201227

pakirano

25 kos/karton
+ PRILožENE NAT. VREČKE

• SLO
IMENA

GREMO NA LEPŠE PO SLOVENIJI



LOGO 330 X 60 MM



LOGO 330 X 60 MM



| | | |
|-------------------|--------------|--|
| A4 | dimenzija mm | 330 X 540 |
| | št. listov | 13 |
| eko tisk | VPC brez ddv | 4,49 € |
| | šifra | 202005 |
| 8 586011 099049 > | pakirano | 25 kos/karton + PRILOŽENE NAT. VREČKE |
| | SLO | SLO |

POSLOVNA SLOVENIJA



LOGO 330 X 60 MM



LOGO 330 X 60 MM



| | | |
|-------------------|--------------|--|
| A4 | dimenzija mm | 330 X 540 |
| | št. listov | 13 |
| eko tisk | VPC brez ddv | 4,59 € |
| | šifra | 201228 |
| 8 586015 030093 > | pakirano | 25 kos/karton + PRILOŽENE NAT. VREČKE |
| | SLO | SLO |
| | IMENA | |

MESTA SLOVENIJE



LOGO 330 X 60 MM



LOGO 330 X 60 MM

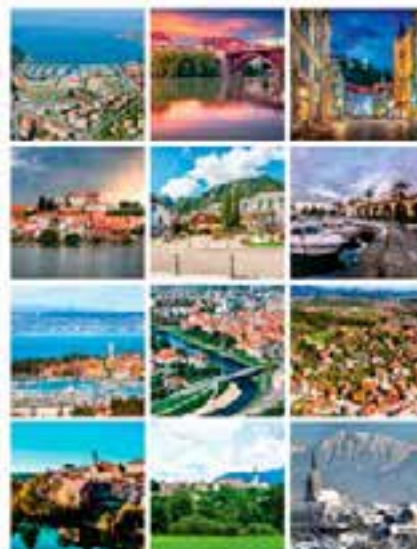

| | | |
|-------------------|--------------|--|
| A4 | dimenzija mm | 330 X 540 |
| | št. listov | 13 |
| eko tisk | VPC brez ddv | 4,39 € |
| | šifra | 202002 |
| 8 586011 011010 > | pakirano | 25 kos/karton + PRILOŽENE NAT. VREČKE |
| | SLO | SLO |
| | IMENA | |



LOGO 295 x 60 mm



LOGO 295 x 60 mm



POTEP PO SLOVENIJI



dimenzija mm

zaprt 295 X 210
odprt 295 X 420

št. listov

13

VPC brez ddv

3,99 €

šifra

201259

pakirano

25 kos/karton
+ PRILožENE NAT. VREČKE

SLO
IMENA



LOGO 300 X 60 MM



LOGO 300 X 60 MM



MOJA SLOVENIJA

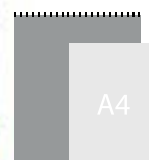

dimenzija mm

zaprt 300 X 360
odprt 300 X 660

št. listov

13

VPC brez ddv

4,89 €

šifra

201222

pakirano

25 kos/karton
+ PRILožENE NAT. VREČKE

SLO
IMENA



LOGO 230 x 50 mm



LOGO 230 x 50 mm



MINI SLOVENIJA



dimenzija mm

230 X 380

št. listov

13

VPC brez ddv

3,25 €

šifra

201280

pakirano

25 kos/karton
+ PRILožENE NAT. VREČKE

SLO
IMENA



LOGO 330 X 60 MM

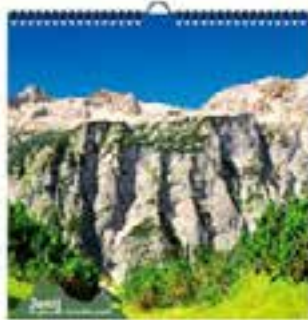

LOGO 330 X 60 MM



SLOVENSKE GORE



dimenzija mm

330 X 540

št. listov

13

VPC brez ddv

3,89 €

šifra

201214

pakirano

25 kos/karton
+ PRILožENE NAT. VPEČKE

• SLO
IMENA

SLOVENSKA JEZERA



LOGO 330 X 60 MM



LOGO 330 X 60 MM



dimenzija mm

330 X 540

št. listov

13

VPC brez ddv

4,49 €

šifra

201253

pakirano

25 kos/karton
+ PRILožENE NAT. VPEČKE

• SLO
IMENA

VODE



LOGO 330 X 60 MM



LOGO 330 X 60 MM



dimenzija mm

330 X 540

št. listov

13

VPC brez ddv

3,89 €

šifra

201215

pakirano

25 kos/karton
+ PRILožENE NAT. VPEČKE

• SLO
IMENA

BARVITOST SLOVENSKE NARAVE



LOGO 330 X 60 MM



LOGO 330 X 60 MM



dimenzija mm

330 X 540

št. listov

13

VPC brez ddv

4,49 €

šifra

202229

pakirano

25 kos/karton
+ PRILožENE NAT. VPEČKE

• SLO
IMENA



LOGO 330 X 60 MM



LOGO 330 X 60 MM

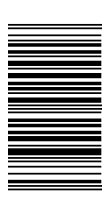

POTEP PO EVROPI

dimenzija mm

330 X 540

št. listov

13

VPC brez ddv

4,49 €

šifra

202230

pakirano

25 kos/karton
+ PRILožENE NAT. VPEČKE

• SLO
IMENA



LOGO 330 X 60 MM



LOGO 330 X 60 MM



CESTE IN POTI

dimenzija mm

330 X 540

št. listov

13

VPC brez ddv

4,49 €

šifra

201206

pakirano

25 kos/karton
+ PRILožENE NAT. VPEČKE

• SLO
IMENA



LOGO 330 X 60 MM



LOGO 330 X 60 MM



BARVE NARAVE



dimenzija mm

330 X 540

št. listov

13

VPC brez ddv

4,59 €

šifra

202003

pakirano

25 kos/karton
+ PRILOŽENE NAT. VPEČKE

SLO

8 586011 011027 >



LOGO 330 X 60 MM



LOGO 330 X 60 MM



GOZDNI ZAKLADI



dimenzija mm

330 X 540

št. listov

13

VPC brez ddv

4,59 €

šifra

201256

pakirano

25 kos/karton
+ PRILOŽENE NAT. VPEČKE

SLO

IMENA

8 586015 018084 >



LOGO 295 x 60 mm



LOGO 295 x 60 mm



NARAVA



dimenzija mm

zaprt 295 X 210
odprt 295 X 420

št. listov

13

VPC brez ddv

3,99 €

šifra

201258

pakirano

25 kos/karton
+ PRILOŽENE NAT. VPEČKE

SLO

IMENA

8 586015 018107 >

LEPOTA VRTOV



LOGO 330 X 60 MM



LOGO 330 X 60 MM



dimenzija mm
330 X 540

št. listov
13

VPC brez ddv
4,49 €

šifra
202004

pakirano
25 kos/karton
+ PRILOŽENE NAT. VREČKE

• SLO
IMENA

eko tisk

8 586011011034 >



LOGO 300 X 60 MM



LOGO 300 X 60 MM



CVETJE

dimenzija mm
zapr 300 X 360
odprt 300 X 660

št. listov
13

VPC brez ddv
4,89 €

šifra
201208

pakirano
25 kos/karton
+ PRILOŽENE NAT. VREČKE

• SLO
IMENA

eko tisk

8 5860151018275 >



LOGO 225 X 60 MM



LOGO 225 X 60 MM



ŠOPKI

dimenzija mm
230 X 540

št. listov
13

VPC brez ddv
3,79 €

šifra
201226

pakirano
25 kos/karton
+ PRILOŽENE NAT. VREČKE

• SLO
IMENA

eko tisk

8 5860151018121 >

SUHO CVETJE



LOGO 330 X 60 MM



LOGO 330 X 60 MM



| | |
|--------------|--|
| dimenzija mm | 330 X 540 |
| št. listov | 13 |
| VPC brez ddv | 4,59 € |
| šifra | 201252 |
| pakirano | 25 kos/karton + PRILOŽENE NAT. VREČKE |
| | • SLO IMENA |

LOV



LOGO 330 X 60 MM



LOGO 330 X 60 MM



| | |
|--------------|--|
| dimenzija mm | 330 X 540 |
| št. listov | 13 |
| VPC brez ddv | 4,39 € |
| šifra | 201257 |
| pakirano | 25 kos/karton + PRILOŽENE NAT. VREČKE |
| | • SLO |

Koristne informacije: lovne dobe, etični kodeks, pravila obnašanja na lovu

PTICE



LOGO 225 X 60 MM



LOGO 225 X 60 MM

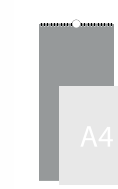

| | |
|--------------|----------------|
| dimenzija mm | 230 X 540 |
| št. listov | 13 |
| VPC brez ddv | 3,79 € |
| šifra | 202232 |
| pakirano | 25 kos/karton |
| | • SLO IMENA |

Koledar je opremljen s fotografijami naravoslovnega fotografa in publicista Borisa Kozinca.



LOGO 300 X 60 MM

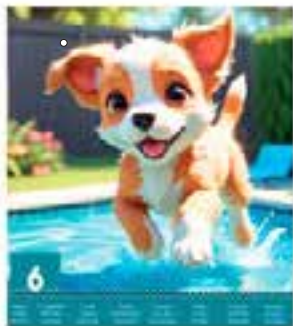

LOGO 300 X 60 MM



PRIKUPNE ŽIVALICE



NOVO

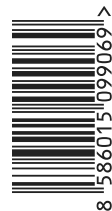

| |
|---|
| dimenzija mm |
| zaprt 300 X 360 odprt 300 X 660 |
| št. listov |
| 13 |
| VPC brez ddv |
| 4,89 € |
| šifra |
| 201275 |
| pakirano |
| 25 kos/karton + PRILOŽENE NAT. VPREČKE |
| ● SLO |
| IMENA |



LOGO 300 X 60 MM



LOGO 300 X 60 MM

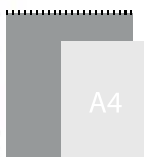

MUCE

| |
|---|
| dimenzija mm |
| zaprt 300 X 360 odprt 300 X 660 |
| št. listov |
| 13 |
| VPC brez ddv |
| 4,89 € |
| šifra |
| 201216 |
| pakirano |
| 25 kos/karton + PRILOŽENE NAT. VPREČKE |
| ● SLO |
| IMENA |



LOGO 300 X 60 MM



LOGO 300 X 60 MM

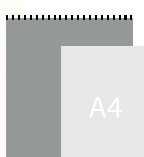

KUŽKI

| |
|---|
| dimenzija mm |
| zaprt 300 X 360 odprt 300 X 660 |
| št. listov |
| 13 |
| VPC brez ddv |
| 4,89 € |
| šifra |
| 201210 |
| pakirano |
| 25 kos/karton + PRILOŽENE NAT. VPREČKE |
| ● SLO |
| IMENA |



LOGO 300 X 60 MM



LOGO 300 X 60 MM

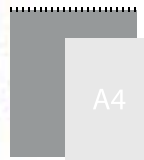

KONJI

dimenzija mm

zaprt 300 X 360
odprt 300 X 660

št. listov

13

VPC brez ddv

4,89 €

šifra

201220

pakirano

25 kos/karton
+ PRILOŽENE NAT. VREČKE

• SLO

IMENA

ČUDESA SVETA



LOGO 330 X 60 MM

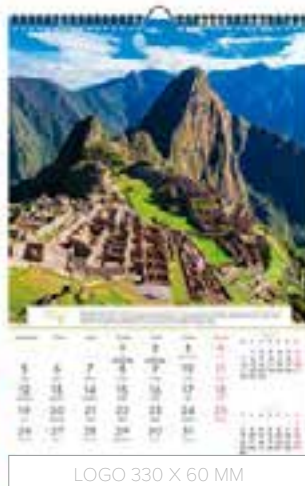

LOGO 330 X 60 MM

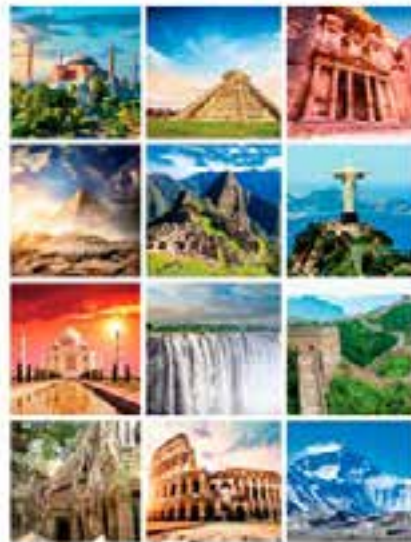

dimenzija mm

330 X 540

št. listov

13

VPC brez ddv

4,59 €

šifra

201281

pakirano

25 kos/karton
+ PRILOŽENE NAT. VREČKE

• SLO

KULINARIKA



LOGO 225 X 60 MM



LOGO 225 X 60 MM



dimenzija mm

230 X 540

št. listov

13

VPC brez ddv

3,79 €

šifra

201277

pakirano

25 kos/karton
+ PRILOŽENE NAT. VREČKE

• SLO

IMENA



LOGO 230 x 50 mm



LOGO 230 x 50 mm



ČAROBNE ZELI



dimenzija mm

230 X 380

št. listov

13

VPC brez ddv

3,25 €

šifra

201245

pakirano

25 kos/karton
+ PRILOŽENE NAT. VREČKE

• SLO

IMENA



SETVENI KOLEDAR



LOGO 230 x 50 mm



LOGO 230 x 50 mm



dimenzija mm

230 X 380

št. listov

13

VPC brez ddv

1,18 €

šifra

201254

pakirano

50 kos/karton

• SLO

IMENA



Koledar je opremljen s podatki po MARIJI THUN.

STARE RAZGLEDNICE



LOGO 225 X 60 MM



LOGO 225 X 60 MM



dimenzija mm

230 X 540

št. listov

13

VPC brez ddv

3,79 €

šifra

201212

pakirano

25 kos/karton
+ PRILOŽENE NAT. VREČKE

• SLO

IMENA



STARE RAZGLEDNICE - VELIKE



LOGO 420 X 60 MM



LOGO 420 X 60 MM

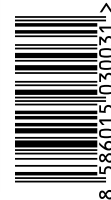

dimenzija mm

420 X 620

št. listov

13

VPC brez ddv

8,99 €

šifra

201250

pakirano

25 kos/karton
+ PRILOŽENE NAT. VPEČKE

• SLO

IMENA

SVETO



LOGO 225 X 60 MM



LOGO 225 X 60 MM

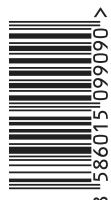

dimenzija mm

230 X 540

št. listov

13

VPC brez ddv

3,99 €

šifra

201278

pakirano

25 kos/karton
+ PRILOŽENE NAT. VPEČKE

• SLO

IMENA

IMPRESIONIZEM



LOGO 420 X 60 MM



LOGO 420 X 60 MM

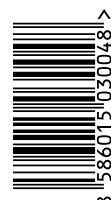

dimenzija mm

420 X 620

št. listov

13

VPC brez ddv

8,99 €

šifra

201251

pakirano

25 kos/karton
+ PRILOŽENE NAT. VPEČKE

SLO

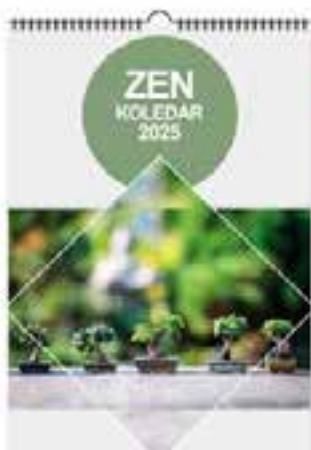

LOGO 230 x 50 mm



LOGO 230 x 50 mm



ZEN

dimenzija mm
230 X 380

št. listov
13

VPC brez ddv
3,25 €

šifra
201279

pakirano
25 kos/karton
+ PRILOŽENE PVC VREČKE

• SLO
IMENA

eko tisk

8 586015 099106 >



LOGO 330 X 60 MM



LOGO 330 X 60 MM



DOMAČIJE SLOVENIJE

dimenzija mm
330 X 540

št. listov
13

VPC brez ddv
4,39 €

šifra
202231

pakirano
25 kos/karton
+ PRILOŽENE NAT. VREČKE

• SLO
IMENA

eko tisk

8 586015 021015 >



LOGO 300 X 60 MM



LOGO 300 X 60 MM



MOTIVACIJSKI KOLEDAR

dimenzija mm
zaprt **300 X 360**
odprt **300 X 660**

št. listov
13

VPC brez ddv
4,89 €

šifra
201276

pakirano
25 kos/karton
+ PRILOŽENE NAT. VREČKE

• ANG SLO
IMENA

eko tisk

8 586015 099076 >



LOGO 230 X 60 MM



LOGO 230 X 60 MM



DRUŽINSKI PLANER



dimenzija mm

230 X 540

št. listov

13

VPC brez ddv

3,99 €

šifra

201255

pakirano

25 kos/karton
+ PRILožENE NAT. VREČKE

SLO

IMENA



8 586015 030222 >

JADRANJE



LOGO 460 X 60 MM

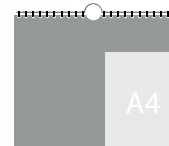

dimenzija mm

460 X 390

št. listov

13

VPC brez ddv

4,89 €

šifra

201269

pakirano

25 kos/karton
+ PRILožENE NAT. VREČKE

SLO



8 586015 018060 >

MOŠKI



LOGO 330 X 60 MM



LOGO 330 X 60 MM



dimenzija mm

330 X 540

št. listov

13

VPC brez ddv

4,39 €

šifra

201204

pakirano

25 kos/karton
+ PRILožENE NAT. VREČKE

SLO



8 586015 018053 >



LOGO 330 X 60 MM



LOGO 330 X 60 MM



HOT GUY



| |
|--|
| dimenzija mm |
| 330 X 540 |
| št. listov |
| 13 |
| VPC brez ddv |
| 4,99 € |
| šifra |
| 201282 |
| pakirano |
| 25 kos/karton + PRILožENE NAT. VPEČKE |
| SLO |



LOGO 330 X 60 MM



LOGO 330 X 60 MM



SANJSKA DEKLETA



| |
|--|
| dimenzija mm |
| 330 x 540 |
| št. listov |
| 13 |
| VPC brez ddv |
| 3,99 € |
| šifra |
| 201340 |
| pakirano |
| 25 kos/karton + PRILožENE NAT. VPEČKE |
| SLO |



LOGO 225 X 60 MM



LOGO 225 X 60 MM



SEXY GIRLS



| |
|--|
| dimenzija mm |
| 230 X 540 |
| št. listov |
| 13 |
| VPC brez ddv |
| 3,79 € |
| šifra |
| 201261 |
| pakirano |
| 25 kos/karton + PRILožENE NAT. VPEČKE |
| SLO |

ZAPELJIVKE



LOGO 330 X 60 MM



LOGO 330 X 60 MM



| | |
|--------------|---|
| dimenzija mm | 330 X 540 |
| št. listov | 13 |
| VPC brez ddv | 3,89 € |
| šifra | 201272 |
| pakirano | 25 kos/karton + PRILOŽENE NAT. VREČKE SLO |

NAGAJIVKE



LOGO 330 X 60 MM



LOGO 330 X 60 MM



| | |
|--------------|---|
| dimenzija mm | 330 X 540 |
| št. listov | 13 |
| VPC brez ddv | 3,99 € |
| šifra | 201213 |
| pakirano | 25 kos/karton + PRILOŽENE NAT. VREČKE SLO |

VROČA DEKLETA



LOGO 330 X 60 MM



LOGO 330 X 60 MM



| | |
|--------------|---|
| dimenzija mm | 330 X 540 |
| št. listov | 13 |
| VPC brez ddv | 3,99 € |
| šifra | 201211 |
| pakirano | 25 kos/karton + PRILOŽENE NAT. VREČKE SLO |

PACKE



LOGO 330 X 60 MM



LOGO 330 X 60 MM



| | |
|--------------|--|
| dimenzija mm | 330 X 540 |
| št. listov | 13 |
| VPC brez ddv | 4,99 € |
| šifra | 201236 |
| pakirano | 25 kos/karton + PRILOŽENE NAT. VREČKE |
| SLO | |

HITRA DEKLETA



LOGO 460 X 60 MM

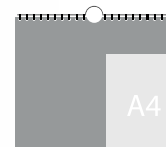

| | |
|--------------|--|
| dimenzija mm | 460 X 390 |
| št. listov | 13 |
| VPC brez ddv | 4,89 € |
| šifra | 201203 |
| pakirano | 25 kos/karton + PRILOŽENE NAT. VREČKE |
| SLO | |

MOTORJI



LOGO 460 X 60 MM

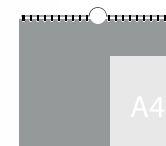

| | |
|--------------|--|
| dimenzija mm | 460 X 390 |
| št. listov | 13 |
| VPC brez ddv | 4,89 € |
| šifra | 201267 |
| pakirano | 25 kos/karton + PRILOŽENE NAT. VREČKE |
| SLO | |



LOGO 460 X 60 MM



TOVORNJAKI

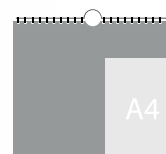

| | |
|--------------|--|
| dimenzija mm | 460 X 390 |
| št. listov | 13 |
| VPC brez ddv | 4,89 € |
| šifra | 201201 |
| pakirano | 25 kos/karton + PRILOŽENE NAT. VREČKE |
| | SLO |



LOGO 230 x 50 mm



LOGO 230 x 50 mm



NOVO JOSIP BROZ TITO



| | |
|--------------|---|
| dimenzija mm | 330 x 540 |
| št. listov | 13 |
| VPC brez ddv | 5,90 € |
| pakirano | 25 kos/karton + PRILOŽENE PVC VREČKE |
| | SLO |
| | IMENA |

NAMIZNI PIRAMIDA



| | |
|--------------|---------------|
| dimenzija mm | 125 X 150 |
| št. listov | 53 |
| VPC brez ddv | 3,79 € |
| šifra | 201234 |
| pakirano | 80 kos/karton |
| | IMENA |
| | SLO HOROSKOP |



NAMIZNI LEŽEČI - DVOBARVNI

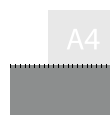

| | |
|--------------|---|
| dimenzija mm | 297 X 150 X 50 |
| št. listov | 53 |
| VPC brez ddv | 3,89 € |
| šifra | 201230 |
| pakirano | 32 kos/karton + PRILOŽENE NAT. VPREČKE |
| ● IMENA | SLO ANG |



NAMIZNI POKONČNI - DVOBARVNI

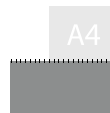

| | |
|--------------|---|
| dimenzija mm | 297 X 150 |
| št. listov | 53 |
| VPC brez ddv | 3,89 € |
| šifra | 201229 |
| pakirano | 50 kos/karton + PRILOŽENE NAT. VPREČKE |
| ● IMENA | SLO ANG |

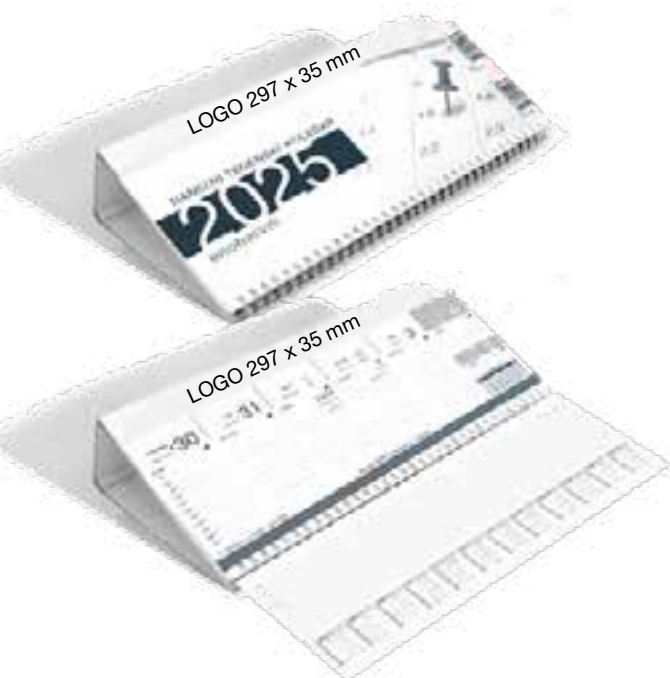

NAMIZNI LEŽEČI - ENOBARVNI

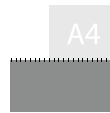

| | |
|--------------|---|
| dimenzija mm | 297 X 150 X 50 |
| št. listov | 53 |
| VPC brez ddv | 3,85 € |
| šifra | 201235 |
| pakirano | 32 kos/karton + PRILOŽENE NAT. VPREČKE |
| ● IMENA | SLO ANG |

NAMIZNI POKONČNI - ENOBARVNI



A4

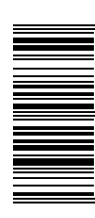

dimenzija mm

297 X 150

št. listov

53

VPC brez ddv

3,85 €

šifra

201231

pakirano

50 kos/karton
+ PRILOŽENE NAT. VREČKE

● IMENA
SLO ANG

POSLOVNI 3D - ŠPIRALA



Zgornji karton lahko naročite
potiskan v izbrani barvi
ali pa brez tiska!



Zatič za aktualni dan

- 201223-0
- 201223-01
- 201223-1
- 201223-2
- 201223-3
- 201223-4
- 201223-5

A4



dimenzija mm

300 x 630

št. listov

12 (x3)

VPC brez ddv

3,49 €

pakirano

50 kos/karton
+ PRILOŽENE NAT. VREČKE

tuji prazniki

● SLO
ANG NEM IT

POSLOVNI 4D - ŠPIRALA



Zatič za aktualni dan



- 201225-0
- 201225-01
- 201225-1
- 201225-2
- 201225-3
- 201225-4
- 201225-5

A4



dimenzija mm

300 x 790

št. listov

12 (x4)

VPC brez ddv

4,49 €

pakirano

40 kos/karton
+ PRILOŽENE NAT. VREČKE

tuji prazniki

● SLO
ANG NEM IT

Zgornji karton lahko naročite
potiskan v izbrani barvi
ali pa brez tiska!

POSLOVNI 3D - LEPLJEN





LOGO 300 x 150 mm

Zgornji karton lahko naročite
potiskan v izbrani barvi
ali pa brez tiska!



Zatič za aktualni dan

-  201224-0
-  201224-01
-  201224-1
-  201224-2
-  201224-3
-  201224-4
-  201224-5



| | |
|---------------|--|
| dimenzija mm | 300 x 630 |
| št. listov | 12 (x3) |
| VPC brez ddv | 3,29 € |
| pakirano | 60 kos/karton + PRILOŽENE NAT. VREČKE |
| tuji prazniki | tuji prazniki |
| |       |
| | <ul style="list-style-type: none"> • SLO ANG NEM IT |



LOGO 250 x 150 mm



POSLOVNI 3D SPECIALNI KARTON - ŠPIRALA

-  201243-1
-  201243-2
-  201243-3
-  201243-4



| | |
|---------------|--|
| dimenzija mm | 250 X 670 |
| št. listov | 12 (x3) |
| VPC brez ddv | 3,99 € |
| pakirano | 50 kos/karton + PRILOŽENE NAT. VREČKE |
| tuji prazniki | tuji prazniki |
| |       |
| | <ul style="list-style-type: none"> • SLO ANG NEM IT |



Zatič za aktualni dan



LOGO 300 x 150 mm

vsi 3 meseci
na enem listu



-  201238-0
-  201238-1
-  201238-2



| | |
|---------------|--|
| dimenzija mm | 300 x 605 |
| št. listov | 12 |
| VPC brez ddv | 3,29 € |
| pakirano | 30 kos/karton + PRILOŽENE NAT. VREČKE |
| tuji prazniki | tuji prazniki |
| |       |
| | <ul style="list-style-type: none"> • SLO ANG NEM IT |



Zatič za aktualni dan

3-MESEČNI POSLOVNI - LEPLJEN

vsi 3 meseci
na enem listu

LOGO 300 x 150 mm



Zatič za aktualni dan

- 201239-0
- 201239-1
- 201239-2



| | |
|---------------|---|
| dimenzija mm | 300 x 630 |
| št. listov | 12 |
| VPC brez ddv | 3,25 € |
| pakirano | 30 kos/karton + PRILOŽENE NAT. VPREČKE |
| tuji prazniki | CZ (A) H (I) D (CR) |
| SLO | • SLO |
| ANG NEM IT | ANG NEM IT |

4-MESEČNI POSLOVNI - ŠPIRALA

vsi 4 meseci
na enem listu

LOGO 300 x 150 mm



Zatič za aktualni dan



Zatič za aktualni dan

- 201240-0
- 201240-1
- 201240-2



| | |
|---------------|---|
| dimenzija mm | 300 x 630 |
| št. listov | 12 |
| VPC brez ddv | 4,29 € |
| pakirano | 30 kos/karton + PRILOŽENE NAT. VPREČKE |
| tuji prazniki | CZ (A) H (I) D (CR) |
| SLO | • SLO |
| ANG NEM IT | ANG NEM IT |

4-MESEČNI POSLOVNI - LEPLJEN

vsi 4 meseci
na enem listu

LOGO 300 x 150 mm



Zatič za aktualni dan



Zatič za aktualni dan

- 201241-0
- 201241-1
- 201241-2



| | |
|---------------|---|
| dimenzija mm | 300 x 630 |
| št. listov | 12 |
| VPC brez ddv | 4,25 € |
| pakirano | 30 kos/karton + PRILOŽENE NAT. VPREČKE |
| tuji prazniki | CZ (A) H (I) D (CR) |
| SLO | • SLO |
| ANG NEM IT | ANG NEM IT |

6-MESEČNI POSLOVNI - ŠPIRALA



vseh 6 mesecev
na enem listu



| | |
|--|----------|
| | 201242-0 |
| | 201242-1 |
| | 201242-2 |



| | |
|--------------|---|
| dimenzija mm | 300 X 630 |
| št. listov | 12 |
| VPC brez ddd | |
| | 4,59 € |
| šifra | 201242 |
| pakirano | |
| | 30 kos/karton + PRILOŽENE NAT. VPREČKE |
| | tuji prazniki |
| | |
| | • SLO |
| | ANG NEM IT |



Zatič za aktualni dan

NAMIZNA PODLOGA



| | |
|--------------|------------------|
| dimenzija mm | 600 X 400 |
| št. listov | 35 |
| VPC brez ddd | |
| | 6,89 € |
| šifra | 201237 |
| pakirano | |
| | 20 kos/karton |
| | SLO |



NOVO KOCKA



| | |
|--------------|----------------|
| dimenzija mm | 45 x 45 |
| št. listov | 356 |
| VPC brez ddd | |
| | 1,48 € |
| | • SLO |
| | IMENA |

BLOKI A5 - ŠPIRALA



dimenzija mm

151 X 121

VPC brez ddv

3,55 €

šifra

201244

pakirano

25 kos/paket
SORTIRANO



ROKOVNIK - ROYAL

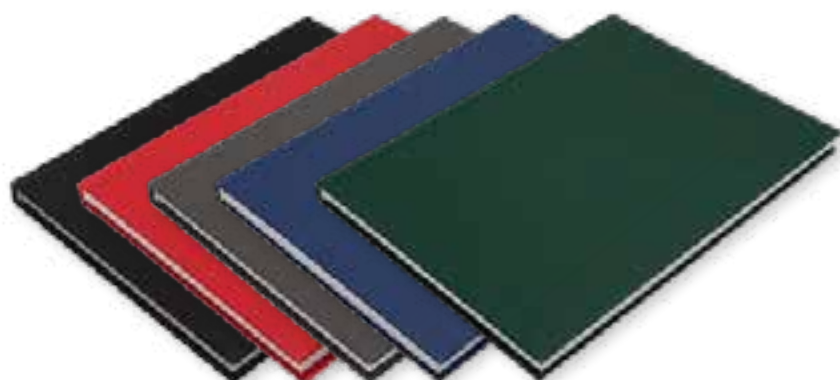

201302-1 modra

201302-2 siva

201302-3 rdeča

201302-4 zelena

201302-5 črna

dimenzija mm

200 X 260

platnica

videz usnja

VPC brez ddv

6,55 €

šifra

201302

pakirano

10 kos/karton



201301-1 modra

201301-2 siva

dimenzija mm

200 X 260

platnica

laminirana
papirna

VPC brez ddv

5,99 €

šifra

201301

pakirano

10 kos/karton



VOŠČILNICE - KOCKA



dimenzija mm

150 X 150

VPC brez ddv

4,89 €

šifra

201233

pakirano

10/1 kos/paket
SORTIRANO

VOŠČILNICE - AMERIKANKE



dimenzija mm

220 x 100

VPC brez ddv

4,89 €

šifra

201232

pakirano

10/1 kos/paket
SORTIRANO

STANDARD

Klasični koledarji in promocijski izdelki



T: 08 385 04 84
08 385 04 81

M: 040 861 890

E: info@partnergraf.si
prodaja@partnergraf.si

W: www.partnergraf.si

PARTNER GRAF zelena tiskarna d.o.o.
Gasilska cesta 3, SI - 1290 Grosuplje

SLOVENIJA K0001



LOGO 330 X 60 mm



LOGO 330 X 60 mm



DIMENZIJA

330 x 540 mm

ŠTEVILO LISTOV

13

VPC BREZ DDV

3,79 €

☐ ● ☐ ○ SLO

IMENA

TUJI PRAZNIKI

(HR) (RS) (IT) (AT)
(DE) (HU) (CZ)

PVC VREČKA

25 KOŠOV / KARTON

SLOVENSKE GORE K0002



LOGO 330 X 60 mm



LOGO 330 X 60 mm



DIMENZIJA

330 x 540 mm

ŠTEVILO LISTOV

13

VPC BREZ DDV

3,79 €

☐ ● ☐ ○ SLO

IMENA

TUJI PRAZNIKI

(HR) (RS) (IT) (AT)
(DE) (HU) (CZ)

PVC VREČKA

25 KOŠOV / KARTON

LEPOTE SLOVENIJE K0024



LOGO 330 X 70 mm



LOGO 330 X 70 mm



DIMENZIJA
330 x 550 mm

ŠTEVILO LISTOV
13

VPC BREZ DDV
4,75 €

SLO
● ● ● ●

PRAZNIKI
SI

PVC VREČKA
40 KOŠOV / KARTON

SLOVENSKE VODE K0003



LOGO 330 X 60 mm



LOGO 330 X 60 mm



DIMENZIJA
330 x 540 mm

ŠTEVILO LISTOV
13

VPC BREZ DDV
3,79 €

● ● ● ● SLO

IMENA
TUJI PRAZNIKI
HR RS IT AT
DE HU CZ

PVC VREČKA
25 KOŠOV / KARTON

ČUDOVITA SLOVENIJA K0004



LOGO 225 X 60 mm



LOGO 225 X 60 mm



DIMENZIJA

225 x 540 mm

ŠTEVILO LISTOV

13

VPC BREZ DDV

3,69 €

● ● ● ○ SLO

IMENA

TUJI PRAZNIKI

HR RS IT AT
DE HU CZ

PVC VREČKA

25 KOSOV / KARTON

LOV K0008

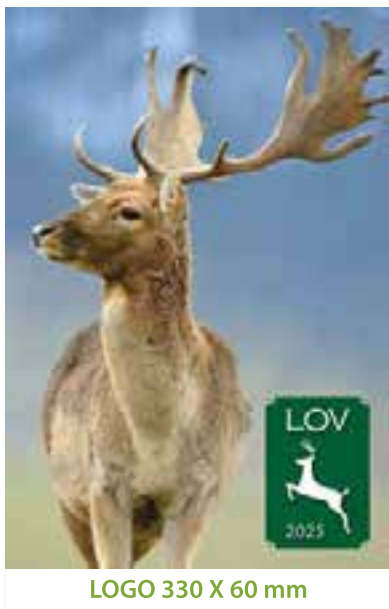

LOGO 330 X 60 mm



LOGO 330 X 60 mm

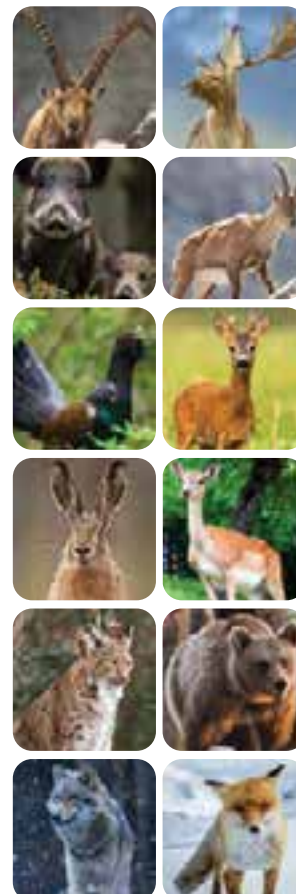

DIMENZIJA

330 x 540 mm

ŠTEVILO LISTOV

13

VPC BREZ DDV

3,89 €

● ● ● ○ SLO

LOVNE DOBE

TUJI PRAZNIKI

HR RS IT AT
DE HU CZ

PVC VREČKA

25 KOSOV / KARTON

ŠOPKI K0006



LOGO 225 X 60 mm



LOGO 225 X 60 mm



DIMENZIJA
225 x 540 mm

ŠTEVILO LISTOV
13

VPC BREZ DDV
3,69 €

☐ ● ☐ ○ SLO

IMENA

TUJI PRAZNIKI

HR RS IT AT
DE HU CZ

PVC VREČKA
25 KOSOV / KARTON

STARE RAZGLEDNICE K0007



LOGO 225 X 60 mm



LOGO 225 X 60 mm

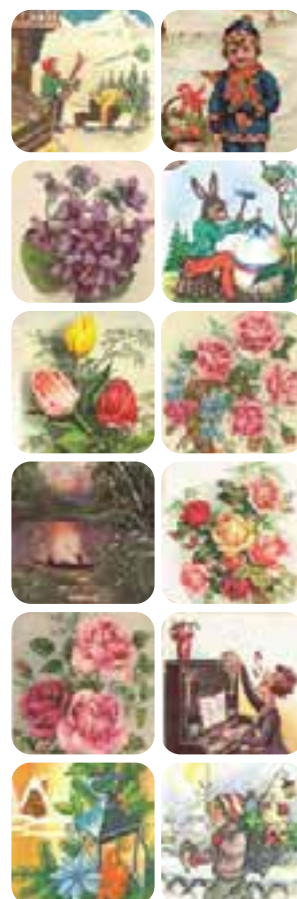

DIMENZIJA
225 x 540 mm

ŠTEVILO LISTOV
13

VPC BREZ DDV
3,69 €

☐ ● ☐ ○ SLO

IMENA

TUJI PRAZNIKI

HR RS IT AT
DE HU CZ

PVC VREČKA
25 KOSOV / KARTON

TITO K0009



LOGO 310 X 60 mm



LOGO 310 X 60 mm



DIMENZIJA

310 x 490 mm

ŠTEVILO LISTOV

13

VPC BREZ DDV

4,90 €

PRAZNIKI

(SI) (YU)

PVC VREČKA
25 KOSOV / KARTON

ZAPELJIVKE K0010



LOGO 330 X 60 mm



LOGO 330 X 60 mm

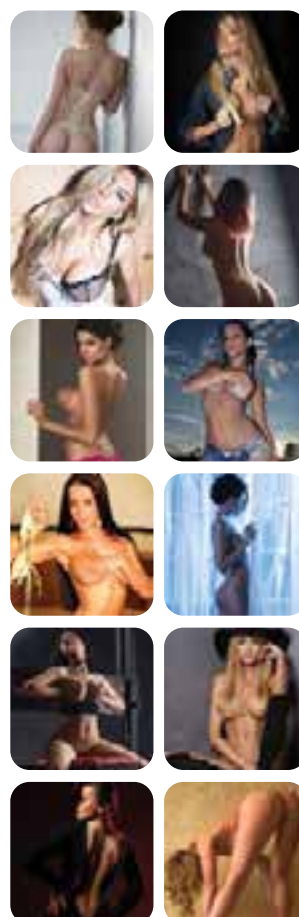

DIMENZIJA

330 x 540 mm

ŠTEVILO LISTOV

13

VPC BREZ DDV

3,89 €

PRAZNIKI

(SI)

PVC VREČKA
25 KOSOV / KARTON

VROČA DEKLETA K0011



LOGO 330 X 60 mm



LOGO 330 X 60 mm



DIMENZIJA

330 x 540 mm

ŠTEVILO LISTOV

13

VPC BREZ DDV

3,89 €

PRAZNIKI

(SI)

PVC VREČKA

25 KOSOV / KARTON

KOLENDAR MOŠKI K0012



LOGO 330 X 60 mm



LOGO 330 X 60 mm



DIMENZIJA

330 x 540 mm

ŠTEVILO LISTOV

13

VPC BREZ DDV

3,89 €

PAKIRANO

25 KOSOV

KOLEDARJI

NAMIZNA PODLAGA K0014



DIMENZIJA

550 x 380mm

ŠTEVILO LISTOV

35

VPC BREZ DDV

5,80 €

☐ ● ☐ ○ SLO

PAKIRANO 20 KOSOV

PRAZNIKI

SI

SETVENI KOLEDAR K0015



DIMENZIJA

230 x 380 mm

ŠTEVILO LISTOV

13

VPC BREZ DDV

1,16 €

☐ ● ☐ ○ SLO

IMENA

PRAZNIKI

SI

NATRON VREČKA

50 KOSOV / KARTON

PODATKI PO MARIJI THUN

PIRAMIDA K0016



DIMENZIJA

100 x 110 mm

ŠTEVILO LISTOV

54

VPC BREZ DDV

3,59 €

☐ ● ☐ ○ SI, DE, GB

IMENA

PRAZNIKI

SI

KOLENDARJI

TRIDELNI KOLEDAR - lepjen K0017



DIMENZIJA
320 x 640 mm

ŠTEVILO LISTOV
13

VPC BREZ DDV
2, 59 €

● ● ● ● SLO
IMENA

NATRON VREČKA
50 KOS / KARTON

TUJI
PRAZNIKI

- HR
- RS
- IT
- AT
- DE
- HU
- CZ

TRIDELNI KOLEDAR - poslovni K0018

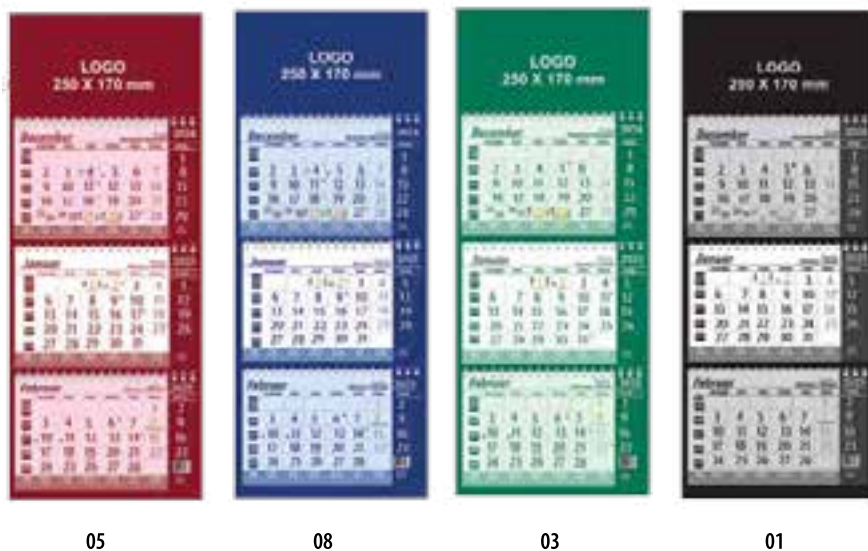

DIMENZIJA
250 x 720 mm

ŠTEVILO LISTOV
13

VPC BREZ DDV
3, 55 €

● ● ● ● SI, DE, GB
IMENA

NATRON VREČKA
50 KOS / KARTON

TUJI
PRAZNIKI

- HR
- RS
- IT
- AT
- DE
- HU
- CZ

TRIDELNI KOLEDAR - IZI K0019



DIMENZIJA
330 x 660 mm

ŠTEVILO LISTOV
13

VPC BREZ DDV
3, 39 €

● ● ● ● SI, DE, GB
IMENA

NATRON VREČKA
50 KOS / KARTON

TUJI
PRAZNIKI

- HR
- RS
- IT
- AT
- DE
- HU
- CZ

KOLEDARJI

ŠTIRIDELNI KOLEDAR - špiralni K0020



DIMENZIJA
300 x 810 mm

ŠTEVILO LISTOV
13

TUJI
PRAZNIKI

- HR
- RS
- IT
- AT
- DE
- HU
- CZ

VPC BREZ DDV
4,49 €

SI, DE, GB
IMENA

NATRON VREČKA
50 KOS / KARTON

NAMIZNI POKONČNI KOLEDAR K0021



DIMENZIJA
300 x 150 mm

ŠTEVILO LISTOV
53

TUJI
PRAZNIKI

- HR
- RS
- IT
- AT
- DE
- HU
- CZ

VPC BREZ DDV
3,79 €

SI, DE, GB
IMENA

NATRON VREČKA
25 KOS / KARTON

NAMIZNI LEŽEČI KOLEDAR K0022



DIMENZIJA
300 x 150 mm

ŠTEVILO LISTOV
53

TUJI
PRAZNIKI

- HR
- RS
- IT
- AT
- DE
- HU
- CZ

VPC BREZ DDV
3,79 €

SI, DE, GB
IMENA

NATRON VREČKA
25 KOS / KARTON

ROKOVNIKI

ROKOVNIK METALIK R0001



01

DIMENZIJA

200 x 260 mm

VPC BREZ DDV

7,89 €

ROKOVNIK VIVA R0002



32

DIMENZIJA

200 x 260 mm

VPC BREZ DDV

7,89 €

ROKOVNIK CLASIK R0003



08

05

01

32

DIMENZIJA

200 x 260 mm

VPC BREZ DDV

7,44 €

ROKOVNIKI

POSLOVNA MAPA 8432



DIMENZIJA

340 x 250 x 26 mm

VPC BREZ DDV

29,80 €



BLOK 8668



DIMENZIJA

328 x 253 x 14 mm

VPC BREZ DDV

14,90 €

BLOKI

PISALNI BLOK 3076



A5

DIMENZIJA

210 x 140 mm

VPC BREZ DDV

2,48 €

BLOKCI 2889



A6

DIMENZIJA

141 x 90 mm

VPC BREZ DDV

1,38 €

BLOKCI 5410

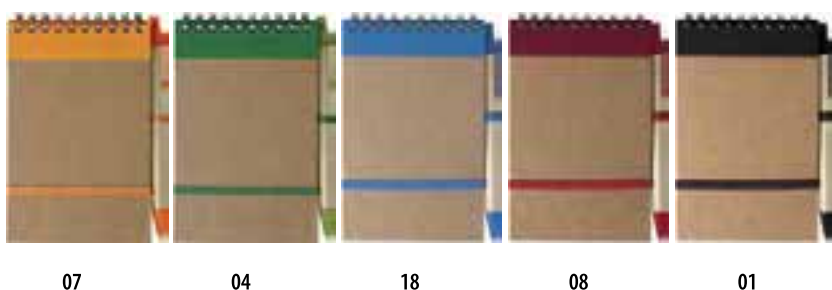

DIMENZIJA

100 x 145 mm

VPC BREZ DDV

1,09 €

BLOKI

PISALNI BLOK 2715



VELIKOST

179 x 131 mm

VPC BREZ DDV

1,98 €



01

08

18

PISALNI BLOK BLACK 8384



PRODAJNI HIT



A5



07



19

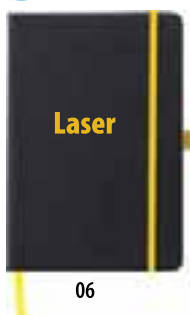

06



05



08



02



18



VELIKOST

210 x 140 mm

VPC BREZ DDV

3,49 €

PRIMEREN ZA LASARSKO GRAVURO
BARVA GRAVURE JE ENAKA BARVI ELASTIKE

VŽIGALNIKI

U - 30 transparentni

v MIX barvah



11264

Cena: 0,19 € + DDV

U - 188 mix

v MIX barvah



11212

Cena: 0,37 € + DDV

U - 188 HC

v MIX barvah



11213

Cena: 0,37 € + DDV

SM - 3 metalic



10399

10400

10402

10403

10404

Cena: 0,49 € + DDV

SM - 3



10392

10393

10394

10395

10397

10396

Cena: 0,44 € + DDV

VIOR one



11936

11937

11935

11938

Cena: 0,29 € + DDV

U - 59 frosty



11330

11332

11328

11327

Cena: 0,38 € + DDV

U - 59



11322

11321

11320

11324

11323

11315

Cena: 0,33 € + DDV

VŽIGALNIKI

VIOR one soft



12208 12209 12210

Cena: 0,36 € + DDV

U - 507 LED



11374 11307 11308 11309 11311 11312

Cena: 0,69 € + DDV

U - 507 LED metallic



11313

Cena: 0,79 € + DDV

U - 201 turbo



11228 11229 11230 11231 11232

Cena: 0,64 € + DDV

EB - 15



10631 10935 10264 10261 10263

Cena: 0,49 € + DDV

U - 360



12089 12090

Cena: 0,49 € + DDV

Cricket Original



293801 293832 293818 293805 293808 293807 293806 293804

Cena: 0,89 € + DDV

Cricket elektronski



191903 191901

Cena: 1,42 € + DDV

RALS



8751709 8751707 8751706 8751704 8751703 8751701 8751702

Cena: 0,39 € + DDV

VŽIGALNIKI

SIMPLE

v MIX barvah 



11939

Cena: 0,29 € + DDV

U - 59 metallic



11325

11326

Cena: 0,47 € + DDV

Bencinski vžigalnik



10880

10879

Cena: 1,48 € + DDV

U - 117 metallic



11209

11201

11203

11208

Cena: 0,44 € + DDV

U - 59 Juicy



11339

11338

11335

11337

11336

Cena: 0,38 € + DDV

U - 30



11257

11258

11259

11262

11263

11260

11261

Cena: 0,19 € + DDV

Pepelnik



4561

Cena: 1,80 € + DDV

Luxemburg



11038

11036

11037

Cena: 1,63 € + DDV

BB - 2



10549

10547

Cena: 1,99 € + DDV

XH - 52



10982

10981

10983

Cena: 1,26 € + DDV

KEMIČNI SVINČNIKI - PLASTIČNI

BRISTOL 3018



01 04 05 07 08 18 19

Cena: 0,23 € + DDV

NEW PORT 3015



01 05 04 08 07 02

Cena: 0,20 € + DDV

OLYMPIC 5210



07 06 04 05

Cena: 0,28 € + DDV

CARDIFF 3011



01 04 05 06 07 08 18 19

Cena: 0,20 € + DDV

TERESA 153



08 01 02 23 07

Cena: 0,28 € + DDV

TRIS 4151



02

Cena: 0,36 € + DDV

AMIGA 161



01 05 02 08 19

Cena: 0,17 € + DDV

KEMIČNI SVINČNIKI - PLASTIČNI

LIP 505



01 23 19 08 06 05

Cena: 0,24 € + DDV

BIS 7580



19 18 01

Cena: 0,27 € + DDV

A 434



24 04 05 08 32

Cena: 0,39 € + DDV

A 533



05 01 08 04

Cena: 0,36 € + DDV

LUX 433



06 01 08 04 07

Cena: 0,28 € + DDV

PERTH 2430



24 05 08 32 06 07

Cena: 0,46 € + DDV

LAURA 3140



18 04 08 07

Cena: 0,21 € + DDV

NET 7910



07 08 18 05 04 01

Cena: 0,17 € + DDV

LEO 029



08 05

Cena: 0,62 € + DDV

KEMIČNI SVINČNIKI - KOVINSKI

KONIN 6250



02 03 04 05 06 08 09 10 11 12 14 29 77

Cena: 0,48 € + DDV
PRIMERNI ZA LASERSKO GRAVURO

POZNAN 6001



31 10 08 04

Cena: 0,48 € + DDV
PRIMERNI ZA LASERSKO GRAVURO

PIP 8463



01 05 32

Cena: 0,42 € + DDV
PRIMERNI ZA LASERSKO GRAVURO

TITANIUM 056



08 07 04 05 02 03 01 23

Cena: 0,56 € + DDV
PRIMERNI ZA LASERSKO GRAVURO

TITANIUM LUX 058



08 06 04 05 03 02 01

Cena: 0,59 € + DDV
PRIMERNI ZA LASERSKO GRAVURO

TITANIUM TOUCH 057



08 06 04 05 03 01

Cena: 0,62 € + DDV
PRIMERNI ZA LASERSKO GRAVURO



MEGA 059



04 23 18 01

Cena: 0,63 € + DDV
PRIMERNI ZA L. GRAVURO



TIM 707



05 08 07 04

Cena: 0,42 € + DDV
PRIMERNI ZA L. GRAVURO



TORUN 6688



01 10 06 13

Cena: 0,58 € + DDV
PRIMERNI ZA L. GRAVURO



SILIKON 0555



03 09 05 04

Cena: 0,52 € + DDV
PRIMERNI ZA L. GRAVURO

KEMIČNI SVINČNIKI - KOVINSKI

KEPNO 6360



01 03 05 06 10 13

Cena: 0,68 € + DDV
PRIMERNI ZA LASERSKO GRAVURO

LUBIN 6450



20 19 17 14 10 06

Cena: 0,69 € + DDV
PRIMERNI ZA LASERSKO GRAVURO

WHITE 067



04 32 05 01 07

Cena: 0,68 € + DDV
PRIMERNI ZA LASERSKO GRAVURO

SUF 088



02 07 04 05 03

Cena: 0,59 € + DDV
PRIMERNI ZA LASERSKO GRAVURO

BLACK 066



23 31 08 07 32 19 18 04

Cena: 0,68 € + DDV
PRIMERNI ZA LASERSKO GRAVURO

FITKO 6211



06 10

Cena: 0,55 € + DDV
PRIMERNI ZA LASERSKO GRAVURO

SOFIJA 11036



08 05 01 03 04

Cena: 0,48 € + DDV
PRIMERNI ZA LASERSKO GRAVURO

PIERRE 436



05 08 04

Cena: 2,29 € + DDV
PRIMERNI ZA LASERSKO GRAVURO

KEMIČNI SVINČNIKI - ECO

NUK 1430

eco



02 04 08 05

Cena: 0,44 € + DDV

WIP 1524

eco



01 02 08 05 04

Cena: 0,20 € + DDV

NATURA 1828

eco



01

Cena: 0,52 € + DDV

BASIC 2019

eco



18 08 04 01

Cena: 0,29 € + DDV

BAMBOO 10054

eco



02 04 08 05

Cena: 0,58 € + DDV

CARTON 316

eco



05 06 07

Cena: 0,24 € + DDV

ELA 313

eco



01

Cena: 0,39 € + DDV

CLASIK 039

eco



05 02 01 32

Cena: 0,09 € + DDV

CLASIK 076

eco



05 08 04

Cena: 0,09 € + DDV

CLASIK 037

eco



01

Cena: 0,09 € + DDV

KEMIČNI SVINČNIKI - SETI

BUM 579



Cena: 1,40 € + DDV

PRIMERNI ZA LASERSKO GRAVURO

KONIN 333



05 03 04

Cena: 1,59 € + DDV

PRIMERNI ZA LASERSKO GRAVURO

IZI 3298



08 23

Cena: 2,99 € + DDV

PRIMERNI ZA LASERSKO GRAVURO

CRYSTAL 6840



08 17 18

Cena: 3,80 € + DDV

PRIMERNI ZA LASERSKO GRAVURO

MAGIC 4410



01 08 18

Cena: 3,99 € + DDV

PRIMERNI ZA LASERSKO GRAVURO

1080 CHARLES DICKENS



01

Cena: 6,90 € + DDV

PRIMERNI ZA LASERSKO GRAVURO

5986 CHARLES DICKENS



01

Cena: 16,90 € + DDV

PRIMERNI ZA LASERSKO GRAVURO

NAUTIC 4420



05

Cena: 24,80 € + DDV

PRIMERNI ZA LASERSKO GRAVURO

PARKER JOTTER 2100



01

Cena: 13,90 € + DDV

PRIMERNI ZA LASERSKO GRAVURO

OBESKI

LESENI OBESKI S1000



01 02 03 04 05 06

Cena: 0,59 € + DDV
PRIMERNI ZA LASERSKO GRAVURO

OBESK - ODPIRAČ 8517



17

08
07
01
04
06
05

Cena: 0,30 € + DDV
PRIMERNI ZA LASERSKO GRAVURO

OBESK LED 1987



32 29 07 05 01

Cena: 0,80 € + DDV

OBESK ŽETON 354



02

06 05

Cena: 0,25 € + DDV

OBESK 2401



21

Cena: 0,49 € + DDV

OBESK ODPIRAČ 476



08

05

Cena: 0,52 € + DDV
PRIMERNI ZA L. GRAVURO

MON 459



04

05

08

Cena: 0,48 € + DDV
PRIMERNI ZA LASERSKO GRAVURO

OBESK LED 8297



05

Cena: 0,88 € + DDV
PRIMEREN ZA LASERSKO GRAVURO

OBESK 5270



30

Cena: 0,88 € + DDV
PRIMEREN ZA L. GRAVURO

OBESK - ODPIRAČ IN METER 1825



08

01

23

Cena: 1,08 € + DDV

OBESK 7126



Cena: 0,62 € + DDV

OBESK 3167



08

02

23

Cena: 0,44 € + DDV

OBESK P001



08

Cena: 0,54 € + DDV

PROMOCIJSKA DARILA

BALZAM 9534



07 29 18

Cena: 0,48 € + DDV

OGLEDALO 1658



18 17

Cena: 0,46 € + DDV

ZLOŽLJIVA KRTAČA 1503



02

Cena: 1,29 € + DDV

OBLIŽI V ŠKATLICI 1020



02 08 23

Cena: 0,38 € + DDV

KRTAČA 6510



02

Cena: 1,99 € + DDV

SONČNA OČALA 9672



01



05



06



08



19



02



17

Cena: 1,20 € + DDV

MASER 20026



Cena: 34,90 € + DDV

SET ZA MANIKURO 7624



32

Cena: 3,30 € + DDV

PROMOCIJSKA DARILA

USB KLJUČ 32 GB 2324



Cena: 7,30 € + DDV

POWERBANK 25401



Cena: 16,30 € + DDV

BREŽIČNA MIŠKA 8578



Cena: 9,90 € + DDV

DODATNA BATERIJA ZA TELEFON 092



Cena: 3,60 € + DDV

MINI SLUŠALKE 2289



Cena: 1,79 € + DDV

SET ZA TELEFON 784 V ETUIJU



Cena: 8,99 € + DDV

URA BUDILKA, POLNILEC Z-1719



Cena: 28,90 € + DDV

PROMOCIJSKA DARILA

DRŽALO ZA MOBILNI TELEFON 1034



01

Cena: 2,28 € + DDV

STRGALO ZA LED 5816



23

21

08

Cena: 0,79 € + DDV

STRGALO ZA LED 8761



02

Cena: 0,34 € + DDV

STRGALO ROKAVICA 5817



01

05

08

Cena: 1,99 € + DDV

USB POLNILNI ADAPTER 3190



02

08

Cena: 0,99 € + DDV

DIŠAVA ZA AVTO 1393



01

Cena: 1,47 € + DDV

PRIMERNA ZA LASERSKO GRAVURO

PARKIRNA URA 6621



05

Cena: 1,39 € + DDV

PARKIRNA URA 8722



05

Cena: 0,99 € + DDV

ZA DOM

SKODELICA 250 ML 614



02

V DARILNI EMBALAŽI
Cena: 2,29 € + DDV



SKODELICA 350 ML 606



02

V DARILNI EMBALAŽI
Cena: 2,98 € + DDV



SKODELICA-KOVINSKA 602



08

05

04

V DARILNI EMBALAŽI
Cena: 3,29 € + DDV



SKODELICA DUO 617



05

19



08

01

07

V DARILNI EMBALAŽI
Cena: 3,35 € + DDV

TERMO STEKLENICA 1103



07

V DARILNI EMBALAŽI
Cena: 9,92 € + DDV



SKODELICA GRETA 4412



05

19

PRIMERNA ZA GRAVIRANJE, V DARILNI EMBALAŽI
Cena: 3,39 € + DDV



STEKLENA SKODELICA F001 250 ML



01

32

08

PRIMERNA ZA GRAVIRANJE, V DARILNI EMBALAŽI
Cena: 3,89 € + DDV



SKODELICA METALIK 603



31

32

PRIMERNA ZA GRAVIRANJE, V DARILNI EMBALAŽI
Cena: 3,49 € + DDV



SKODELICA BREAKFAST 4407



08

32

PRIMERNA ZA GRAVIRANJE
Cena: 3,89 € + DDV



BIDON STEKLEN 9381



19

08

05

V DARILNI EMBALAŽI
Cena: 2,28 € + DDV



ZA DOM

SVEČNIK 482



01

Cena: 0,80 € + DDV

ODPIRAČ 7240



23

10

Cena: 4,40 € + DDV

ODPIRAČ STEKLENICA 046



01

Cena: 1,99 € + DDV

KUHINJSKA DESKA IZ BAMBUSA 124902



150 x 200 x 10 MM

02

Cena: 2,69 € + DDV

SET ZA VINO 6832



01

Cena: 14,40 € + DDV

SOBNI COPATI 428



05

03

Cena: 2,59 € + DDV

SET ZA ŽAR 2631



01

Cena: 26,90 € + DDV

DROBILEC SOLI IN POPRA 3724



Cena: 19,90 € + DDV

POSODA ZA HRANO 062



05

Cena: 3,90 € + DDV

ANTISTRES ŽOGICA 3965

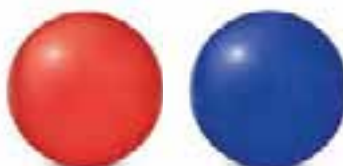

08

23

Cena: 0,66 € + DDV

PASJI FRIZBI 2525



05

Cena: 0,69 € + DDV

ZA DOM - OTROCI

DOMINE 1005



Cena: 1,99 € + DDV

BARVICE 2432



Cena: 0,26 € + DDV

BARVICE 2497



08

18

Cena: 0,54 € + DDV

NOGOMETNA ŽOGA 897



02

Cena: 5,90 € + DDV

MIKADO 2548



23

Cena: 1,49 € + DDV

KARTE 710073



Cena: 1,49 € + DDV

PRAVLJICA 0311



Cena: 8,00 € + DDV

DELOVNI ZVEZEK A4 03117



Cena: 4,00 € + DDV

PRAVLJICA 11125



Cena: 8,00 € + DDV

PRAVLJICI 131129

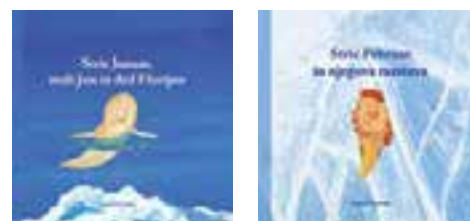

Cena: 5,00 € + DDV

ZDRAVJE

MEDICINSKA MASKA 0413



Cena: 0,04 € + DDV

MASKA FFP2 0411



Cena: 0,29 € + DDV

PRALNA MASKA 0409



Cena: 1,99 € + DDV

OSVEŽILNI ROBČKI 6080



23



32

Cena: 1,19 € + DDV

1110 RAZKUŽILO ZA ROKE

10 ML



05

08

Cena: 0,86 € + DDV

3589 RAZKUŽILO ZA ROKE

20 ML



Cena: 1,62 € + DDV

MERILEC KRVNEGA TLAKA 10225



Cena: 39,00 € + DDV

MULTIFUNKCIJSKA URA 120



01

Cena: 9,90 € + DDV

MERILNIK TELESNE TEMPERATURE 10230



Cena: 14,90 € + DDV

PISARNA

STOJALO 8831



Cena: 0,19 € + DDV

SAMOLEPILNI LISTIČI 5916



UGODNO

Cena: 1,70 € + DDV

POVEČEVALNO STEKLO 7705



Cena: 0,26 € + DDV

RAVNILO 7284



Cena: 0,42 € + DDV

RAVNILO 2413



Cena: 0,79 € + DDV

NAMIZNA URA 4789



Cena: 12,60 € + DDV

ODPIRALEC PISEM 4505



02

01

Cena: 0,39 € + DDV

KALKULATOR 4050



01

Cena: 7,90 € + DDV

KALKULATOR 4488



Cena: 2,68 € + DDV

8011

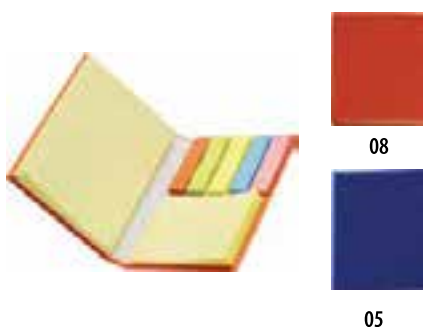

08

05

Cena: 1,49 € + DDV

SAMOLEPILNI LISTIČI 8005



Cena: 5,39 € + DDV

PISARNIŠKI SET 6498



Cena: 3,20 € + DDV

PISARNA

LEPILNI TRAK 324232



Cena: 1,99 € + DDV

LEPILNI TRAK 324233



Cena: 1,99 € + DDV

MAGIČNI LEPILNI TRAK 324234



Cena: 1,49 € + DDV

BLOK KOČKA 324235



Cena: 2,89 € + DDV

NAMIZNI KALKULATOR 324236



Cena: 15,90 € + DDV

FOTOKOPIRNI PAPIR 324238



Cena: 8,90 € + DDV

MAPA PP 22 X 30 (50 KOS) 324237



Cena: 4,10 € + DDV

REGISTRATOR 324239



05

06

08

04

Cena: 3,99 € + DDV

DELO

METER 167 3 M



3 M

01

Cena: 1,59 € + DDV

METER 168 5 M



5 M

01

Cena: 2,20 € + DDV

NOŽ 8540



05



04



08

Cena: 0,49 € + DDV

IZVIJAČ 3117



03

Cena: 3,89 € + DDV

PRIMEREN ZA L. GRAVURO

ŽEPNI NOŽ 7112



Cena: 2,63 € + DDV

PRIMEREN ZA LASERSKO GRAVURO

SVETILKA 8196



Cena: 6,20 € + DDV

NAGLAVNA SVETILKA 287



01

Cena: 4,60€ + DDV

NAGLAVNA SVETILKA 545



01

Cena: 1,99 € + DDV

ROČNA SVETILKA 7880



23



01



08



19

Cena: 2,96 € + DDV

ZAPESTNICA 6084

32 CM



32



06

Cena: 0,39 € + DDV

ZAPESTNICA 025

23 CM



06



32

Cena: 0,22 € + DDV

PRIPONKA 8961



Cena: 0,24 € + DDV

POTOVANJE

BOMBAŽNA VREČA 2342



Cena: 1,19 € + DDV

DENARNICA ZA OKOLI VRATU 444



01

Cena: 1,99 € + DDV

NAKUPOVALNA VREČKA 173

36 x 40 CM
NON WOVEN



05

01

08

Cena: 0,55 € + DDV

HLADILNA TORBA 098



05

06

04

Cena: 2,69 € + DDV

EURO DENARNICA 666



01

Cena: 3,18 € + DDV

DENARNICA PODKEV 555



01

Cena: 2,99 € + DDV

POTOVALKA 7658



Cena: 13,90 € + DDV

NAHRBTNIK COOL 4385



01

05

04

Cena: 7,90 € + DDV

POTOVALKA 153



05

01

Cena: 8,90 € + DDV

POSLOVNA TORBA 0920



01

Cena: 7,90 € + DDV

DARILNA EMBALAŽA

BUTELJČNA VREČKA 14839



30

02

05

08

04

32

14 x 8 x 38 cm

Cena: 0,55 € + DDV

DARILNA ŠKATLA MAXI



22 x 22 x 16 cm

Cena: 4,10 € + DDV

DARILNA VREČKA VELIKA 261235



30

02

05

08

04

32

Velikost 26 x 12 x 35 cm

Cena: 0,59 € + DDV

DARILNA ŠKATLA JUMBO



Velikost 25 x 41 x 10 cm

Cena: 4,73 € + DDV

DARILNA VREČKA JUMBO



30

02

05

08

04

32

Velikost 32 x 12 x 41 cm

Cena: 0,67 € + DDV

DEŽNIKI

ZLOŽLJIV DEŽNIK 4092



01



08



05



18

Cena: 4,39 € + DDV

DEŽNIK GOLF 4087



29



18



05

Cena: 12,90 € + DDV

DEŽNIK ELEGANT 4096



01



04



05

Cena: 7,86 € + DDV

DEŽNIK LES AVTOMAT 4070



07



06



19



08



10



01



04



03



05

Cena: 4,82 € + DDV

TEKSTIL

BRISAČA 361



05



18



02



08



19

30 x 50 cm

Cena: 1,69 € + DDV

BRISAČA 362



05



18



02



08



19

50 x 100 cm

Cena: 4,92 € + DDV

BRISAČA 363



05



18



02



08



19

70 x 140 cm

Cena: 8,90 € + DDV



ROKAVICE PINTO



6 - 11

Cena: 0,99 € + DDV

ROKAVICE 5350



ROKAVICE ZA PAMETNI TELEFON

Cena: 1,69 € + DDV

TEKSTIL

KAPA 1741



200 g/m²
Flis Anti piling (ne pušča
muck)



Cena: 2,20 € + DDV

KARIBAN KAPA KP011



260 g/m²
100 % brušen bombaž
6 panel

Kontrastna sandwich
kombinacija

Kovinska zaponka



Cena: 3,60 € + DDV

ZIMSKA KAPA N008



01



03



05



19



18

Cena: 2,49 € + DDV

TEKSTIL

SOL'S REGENT ŽENSKA MAJICA 150 g/m²



S - 2 XL



Apple Green
Aqua
Atoll Blue
Dark Purple
Deep Black
Duck Blue
Fuschsia
Gold
Grey Melange
Kelly Green
Lemon
Lime



Navy
Orange
Orchid Pink
Red
Royal Blue
Sky Blue
White

Rok dobave 3 - 4 dni

SOL'S COLLECTION

Cena bele T-Shirt: 3,40 € + DDV
Cena barvne T-Shirt: 3,99 € + DDV

SOL'S REGENT MOŠKA MAJICA 150 g/m²



XS - 2 XL



Apple Green
Aqua
Army
Atoll Blue
Burgundy
Dark Purple
Denim
Duck Blue
Kelly Green
Lemon
Lime
Mouse Grey
Sand
Sky Blue
Zinc



Bottle Green
Deep Black
Yellow
Gray
Navy
Orange
Red
Royal Blue
White

Rok dobave 3 - 4 dni

SOL'S COLLECTION

Cena bele T-Shirt: 3,40 € + DDV
Cena barvne T-Shirt: 3,99 € + DDV

GILDAN 5000

GI5000

Heavy Cotton
T-Shirt



S - 2 XL



100 % bombaž
175 g/m²: bela, 185 g/m²: ostale barve

Rok dobave 3 - 4 dni

Cena bele T-Shirt: 3,50 € + DDV
Cena barvne T-Shirt: 3,99 € + DDV

Zaloga v Sloveniji: črna, bela, navy, rdeča

TEKSTIL

Gi64800 Polo majica 180 g/m²



180 g/m²
100 % bombaž
Rok dobave 3 - 4 dni

S - 4 XL



Cena: 7,92 € + DDV

SOL'S FLIS 5400-ž / 5500-m



300 g/m²
100 % poliester
Klasični kroj,
elastika na rokavih
Anti piling (ne pušča muck)
Dva žepa na zadrگو
Rok dobave 3 - 4 dni

XS - 5XL m

S - 2XL ž



Cena: 23,42 € + DDV

Kariban Softshell 400 - ž / 401 - m



300 g/m²
95 % poliester, 5 % elasthan
Softshell 3 stranski šiti material
Zračen do 3000 gsm/24 h
Vodoodporen do 8000 mm
Rok dobave 3 - 4 dni

S - 4XL



Cena: 46,99 € + DDV

TEKSTIL

ZAŠČITNA JAKNA - REFLEKTIVNA



Cena: 58,80 € + DDV

ZAŠČITNE HLAČE - REFLEKTIVNE



Cena: 53,20 € + DDV

ZAŠČITNE FARMER HLAČE - REFLEKTIVNE



Cena: 58,20 € + DDV

HLAČE NA PAS EXCLUSIVE

S - 3 XL



Cena: 46,80 € + DDV

FARMER HLAČE EXCLUSIVE

S - 3 XL



Cena: 49,80 € + DDV

DELOVNA JAKNA EXCLUSIVE

S - 3 XL



Cena: 56,80 € + DDV

BREZROKAVNIK EXCLUSIVE

S - 3 XL



Cena: 36,90 € + DDV

ČEVLJI EXCLUSIVE - VISOKI

37-47



Cena: 56,82 € + DDV

ČEVLJI EXCLUSIVE - NIZKI

37-47



Cena: 56,62 € + DDV

PREMIUM

Klasični koledarji in usnjeni rokovniki



T: 08 385 04 84
08 385 04 81

M: 040 861 890

E: info@partnergraf.si
prodaja@partnergraf.si

W: www.partnergraf.si

PARTNER GRAF zelena tiskarna d.o.o.
Gasilska cesta 3, SI - 1290 Grosuplje



ROKOVNIKI

MOŽNOST TISKANJA LOGOTIPA



Tampo
tisk



Slepi
tisk



Termo
tisk



Sitotisk



Digitalni
tisk

TONDA, TAVOLO, PORTA, DUO, COUNTRY,
BORGO, MORENA, TEODORO



Tampo
tisk



Slepi
tisk



Sitotisk



Digitalni
tisk

MARANO

1

1 ROKOVNIKI



TONDA

POSLOVNIK

810800 modra **810806** rdeča **810736** zelena
810803 črna **810809** siva **810739** srebrna

Format: 200 x 269 mm
192 strani, 80 gsm, bel papir



1/20 str.15

7,40 €

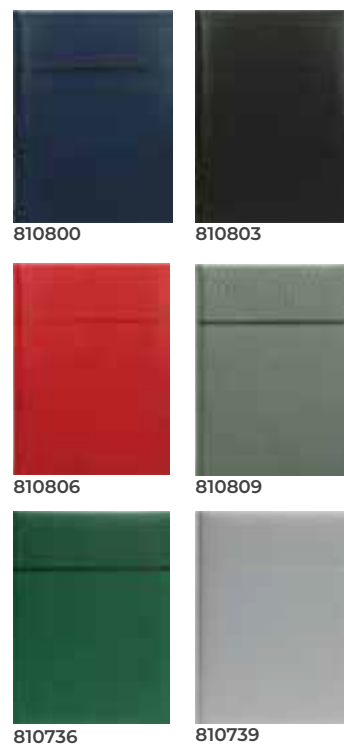

TONDA

DNEVNIK

- 810801** modra
- 810804** črna
- 810807** rdeča
- 810810** siva
- 810740** srebrna

Format: 172 x 243 mm
192 strani, 80 gsm, bel papir



1/20 str.15

6,30 €



810801



810804



810807



810810



810740

TONDA

PLANER

- 810802** modra
- 810805** črna
- 810808** rdeča
- 810811** siva
- 810741** srebrna

Format: 80 x 160 mm
144 strani, 80 gsm, bel papir



1/100 str.15

3,60 €



810802



810805



810808



810811



810741

TAVOLO

POSLOVNIK

810812 modra
810815 siva

Format: 200 x 269 mm
192 strani, 80 gsm, bel papir



1/20 str.15

7,40 €

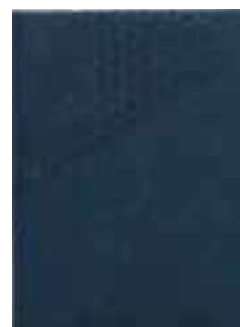

810812



810815

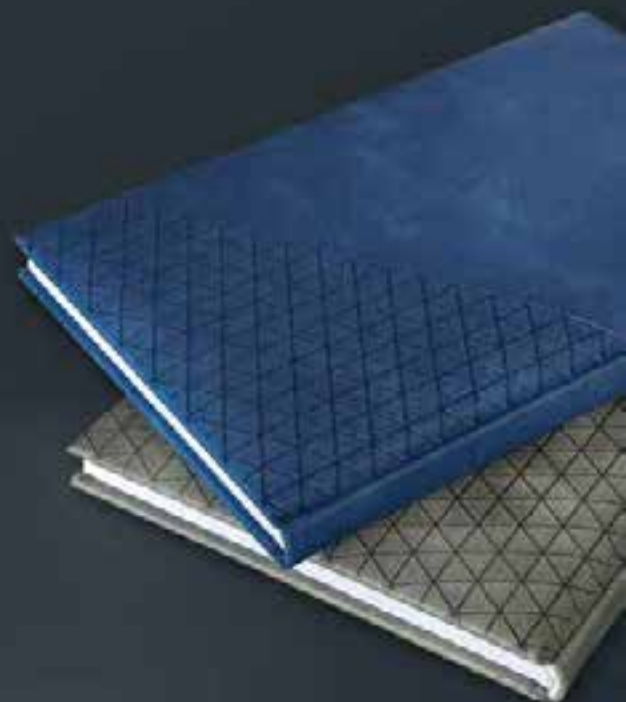

TAVOLO

DNEVNIK

810813 modra
810816 siva

Format: 172 x 243 mm
 192 strani, 80 gsm, bel papir



1/20 str.15

6,30 €



810813



810816

TAVOLO

PLANER

810814 modra
810817 siva

Format: 80 x 160 mm
 144 strani, 80 gsm, bel papir



1/100 str.15

3,60 €



810814



810817

PORTA

POSLOVNIK

810818 modra

810820 siva

Format: 200 x 269 mm
192 strani, 80 gsm, bel papir



1/20 str.15

6,90 €



810818



810820

PORTA

DNEVNIK

810819 modra

Format: 172 x 243 mm
192 strani, 80 gsm, bel papir



1/20 str.15

5,90 €



810819

PORTA

PLANER

810750 modraFormat: 80 x 160 mm
144 strani, 80 gsm, bel papir

1/100 str.15

3,60 €**810750**

DUO

POSLOVNIK

810824 črna/sivaFormat: 200 x 269 mm
192 strani, 80 gsm, bel papir

1/20 str.15

7,70 €

COUNTRY

POSLOVNIK

810826

Format: 200 x 269 mm
192 strani, 80 gsm, bel papir



1/20 str.15

7,70 €



810826



BORGO

POSLOVNIK

- 810617** modra
- 810618** črna
- 810619** rjava

Format: 200 x 269 mm
192 strani, 80 gsm, bel papir



1/20 str.15

7,40 €



810617



810618



810619



MARANO

POSLOVNIK

800327 rdeča

800328 temno modra

Format: 200 x 269 mm

192 strani, 80 gsm, bel papir



1/20 str.15

6,90 €

DNEVNIK

800329 rdeča

800330 temno modra

Format: 172 x 243 mm

192 strani, 80 gsm, bel papir



1/20 str.15

6,90 €

MORENA

POSLOVNIK

810606 rdeča

Format: 200 x 269 mm

192 strani, 80 gsm, bel papir



1/20 str.15

7,40 €

800327



8000329

800328



800330



810606

TEODORO

POSLOVNIK

810707 rdeča**810710** sivaFormat: 200 x 269 mm
192 strani, 80 gsm, bel papir

1/20 str.15

7,40 €**810707****810710**

TEODORO

DNEVNIK

810705 modra**810708** rdečaFormat: 172 x 243 mm
192 strani, 80 gsm, bel papir

1/20 str.15

6,30 €**810708****810705**

POSLOVNIK TEDENSKI Z DATUMI

810634

Format: 200 x 269 mm
192 strani, 80 gsm, bel papir



1/20 str.15

7,90 €



810634



DNEVNIK Z DATUMI B5

800379

Format: 172 x 243 mm
384 strani, 80 gsm, bel papir



1/20 str.15

8,20 €



800379



NOTRANJOST ROKOVNIKOV

**POSLOVNIK TEDENSKI
Z DATUMI**

200 x 269 mm/80 gsm/192 strani

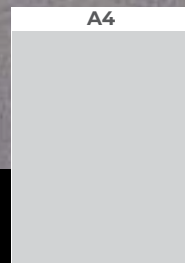

DNEVNIK Z DATUMI B5

172 x 243 mm/80 gsm/384 strani



POSLOVNIK

200 x 269 mm/80 gsm/192 strani

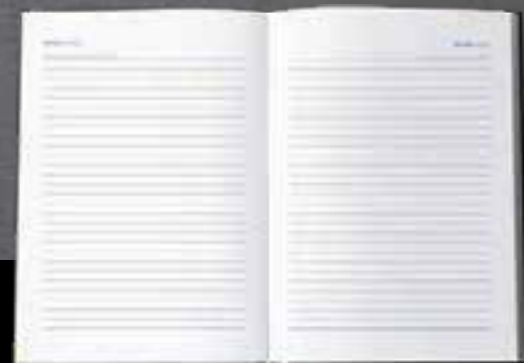

DNEVNIK

172 x 243 mm/80 gsm/192 strani



PLANER

80 x 160 mm/80 gsm/144 strani



2 KOLEDARJI

KOLEDARJI

NAMIZNI
STENSKI

2



NAMIZNI LEŽEČI

KOLEDAR - MODER

810578

290 x 160 mm



3,95 €

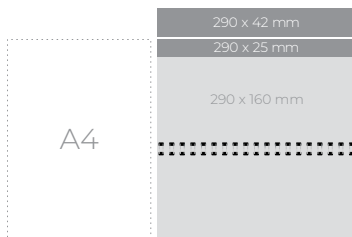

NAMIZNI LEŽEČI

KOLEDAR - SIV

810579

Format: 300 x 150 cm



3,90 €

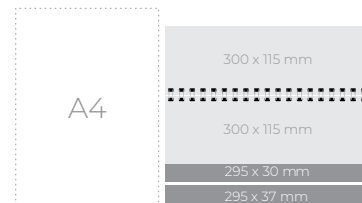

NAMIZNI POKONČNI

KOLEDAR - MODER

810580

290 x 160 mm



3,75 €



NAMIZNI LEŽEČI

KOLEDAR - EKO

810735

Format: 300 x 150 cm



3,75 €

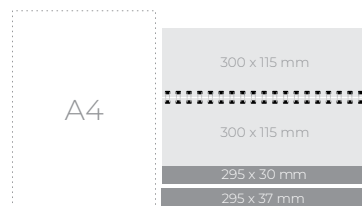

2 KOLEDARJI

NAMIZNI PLANER

KOLEDAR KOCKA

81666

Format: 45 x 45 x 30 mm



250/1

1,75 €



NAMIZNI KOLEDAR

KOLEDAR - BEL

810722

Format: 120 x 110 x 130 mm
Prostor za LOGO: 100 x 20 mm
Tedenski koledar



120/1

3,59 €



NAMIZNI KOLEDAR

KOLEDAR - MODER

810723

Format: 120 x 110 x 130 mm
Prostor za LOGO: 100 x 20 mm
Tedenski koledar



120/1

3,59 €



NAMIZNI LEŽEČI

KOLEDAR - PLEXI

810724

Format: 215 x 180 x 50 mm
Prostor za LOGO: 200 x 25 mm
Tedenski koledar



60/1

6,05 €



VLOŽEK ZA PLEXI KOLEDAR

KOLEDAR - VLOŽEK

810725

Format: 100 x 140 x 5 mm
Tedenski koledar



350/1

1,65 €



STENSKI PLANER

KOLEDAR V TULCU (10 kos)

810581

Format: 1000 x 700 mm
Prostor za LOGO: 1000 x 700 mm



10/1

28,00 €

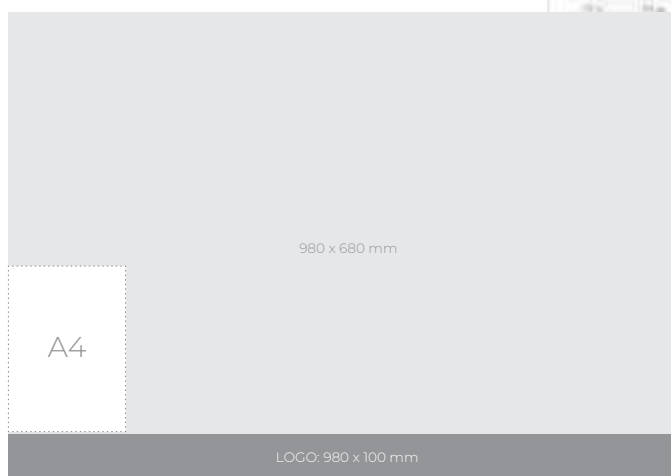

NAMIZNA PODLOGA

- 810589** modra
- 810733** srebrna
- 810591** črna
- 810590** rdeča

Format: 600 x 400 mm, 25 listov
Prostor za LOGO: 600 x 50 mm



1/10

6,60 €



810589



810733



810590



810591



2 KOLEDARJI

TRIDELNI ŠPIRALNI

STENSKI KOLEDAR

- 810597** rdeča
- 810594** modra
- 810595** bela
- 810596** črna

Format: 245 x 700 mm
Prostor za LOGO: 250 x 170 mm



1/50

3,75 €



245x 700 mm
označevalec dneva



810597



810594



810595



810596

ŠTIRIDELNI ŠPIRALNI

STENSKI KOLEDAR

810593

Format: 245 x 880 mm
 Prostor za LOGO: 250 x 170 mm



5,60 €

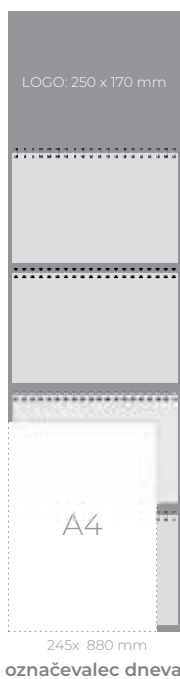

810593

TRIDELNI ŠPIRALNI

STENSKI KOLEDAR - EKO

810703

Format: 245 x 700 mm
 Prostor za LOGO: 250 x 170 mm



3,80 €

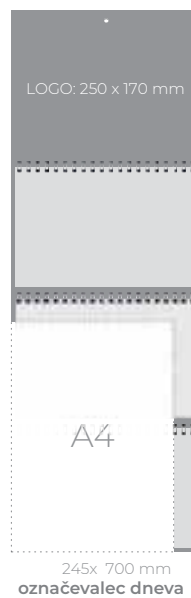

810703



2 KOLEDARJI



ŠTIRIDELNI ŠPIRALNI

STENSKI KOLEDAR

810732

Format: 305 x 800 mm
Prostor za LOGO: 305 x 150 mm



1/50

4,95 €



810732

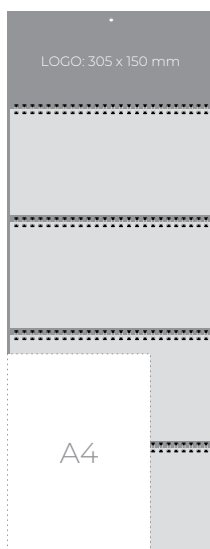

305 x 800 mm
označevalec dneva

ŠTIRIDELNI ŠPIRALNI

STENSKI KOLEDAR

810583

Format: 305 x 800 mm
Prostor za LOGO: 305 x 150 mm



1/50

4,95 €



810583

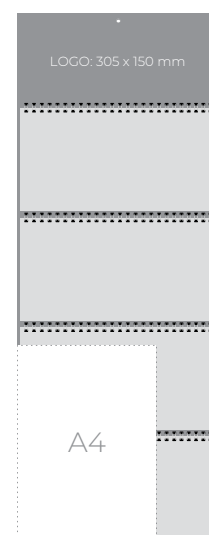

305 x 800 mm
označevalec dneva



TRIDELNI LEPLJEN

STENSKI KOLEDAR

810734

Format: 305 x 660 mm
Prostor za LOGO: 300 x 150 mm



1/50

3,30 €



305 x 660 mm
označevalec dneva



810734

TRIDELNI ŠPIRALNI

STENSKI KOLEDAR

810584

Format: 305 x 660 mm
Prostor za LOGO: 305 x 150 mm



1/50

3,60 €

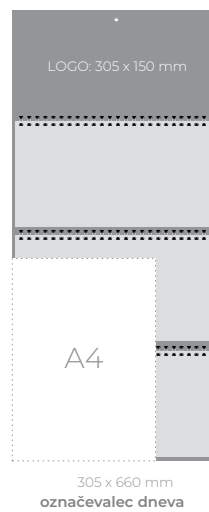

810584

ŠTIRIMESEČNI

STENSKI KOLEDAR S PLANERJEM

810582

Format: 305 x 660 mm
Prostor za LOGO: 305 x 150 mm



1/50

2,95 €

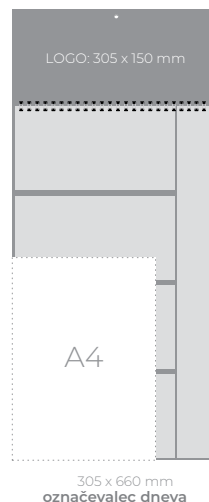

810582

2 KOLEDARJI

LEPOTE GORA

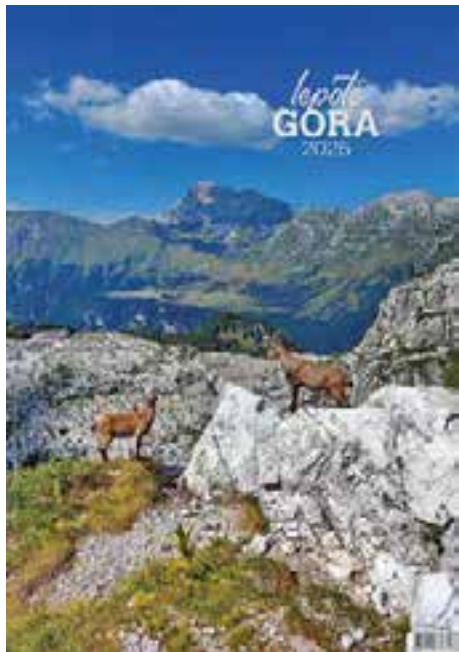

STENSKI KOLEDAR

810702

Format: 330 x 480 mm
Prostor za LOGO: 330 x 50 mm



1/50

4,20 €

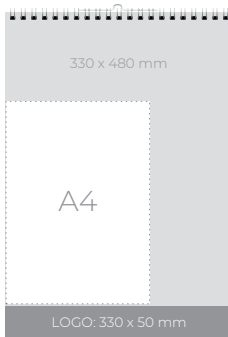

BISERI SLOVENIJE

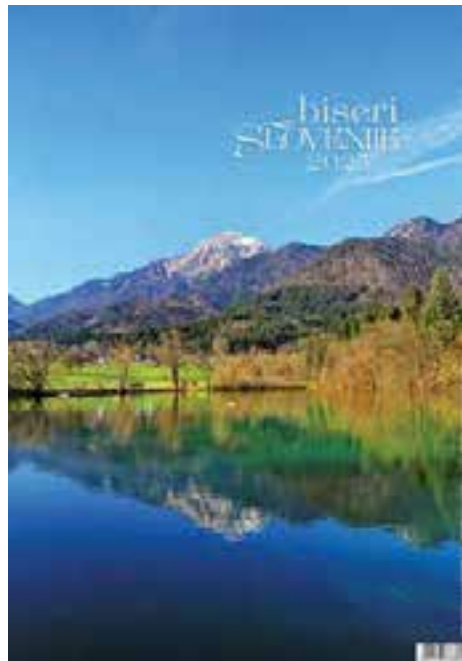

STENSKI KOLEDAR

810585

Format: 330 x 480 mm
Prostor za LOGO: 330 x 50 mm



1/50

3,95 €

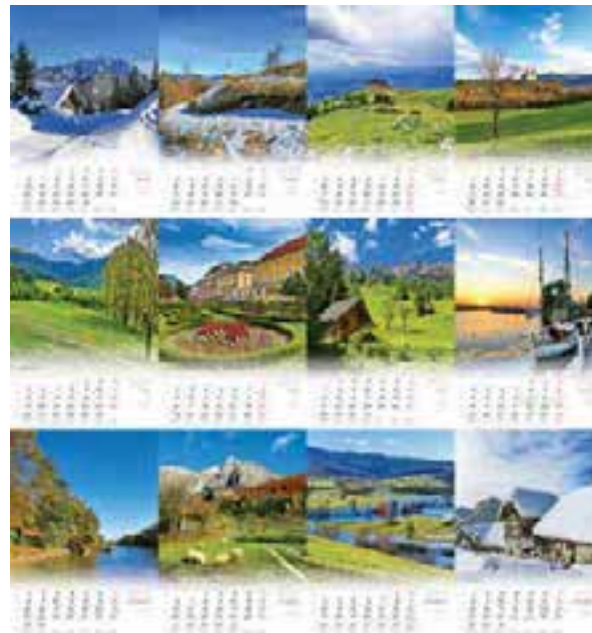
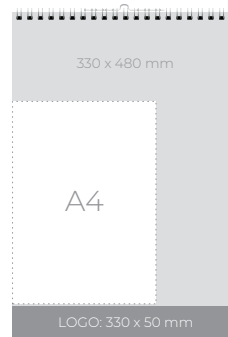

GORE IN LJUDJE

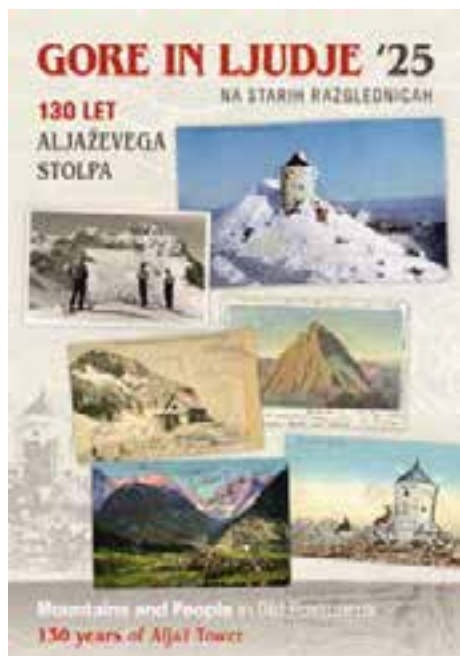

STENSKI KOLEDAR

810602

Format: 335 x 475 mm
 Prostor za LOGO: 335 x 50 mm



4,99 €

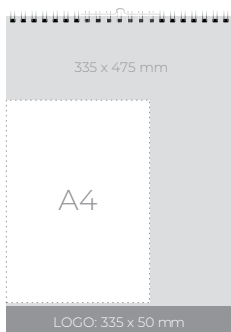

SLOVENSKE GORE



STENSKI KOLEDAR

810598

Format: 330 x 480 mm
 Prostor za LOGO: 330 x 50 mm



3,95 €



2 KOLEDARJI

DOBROTE PO DOMAČE

STENSKI KOLEDAR

810599

Format: 228 x 450 mm
Prostor za LOGO: 228 x 50 mm



1/50

3,95 €

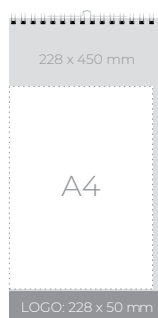

SETVENI

STENSKI KOLEDAR

810592

Format: 230 x 330 mm
Prostor za LOGO: 230 x 50 mm



1/50

1,19 €



MOTORJI

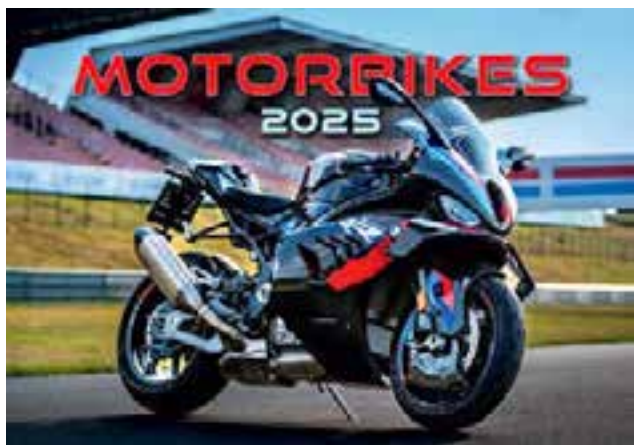

STENSKI KOLEDAR

810719

Format: 450 x 315 mm
 Prostor za LOGO: 450 x 70 mm



1/10

6,50 €



AVTOMOBILI



STENSKI KOLEDAR

810718

Format: 450 x 315 mm
 Prostor za LOGO: 450 x 70 mm



1/10

6,50 €



2 KOLEDARJI

GOLE ŽENSKE



STENSKI KOLEDAR

810601

Format: 330 x 480 mm
Prostor za LOGO: 330 x 50 mm



1/50

3,95 €



ŽENSKE ČB

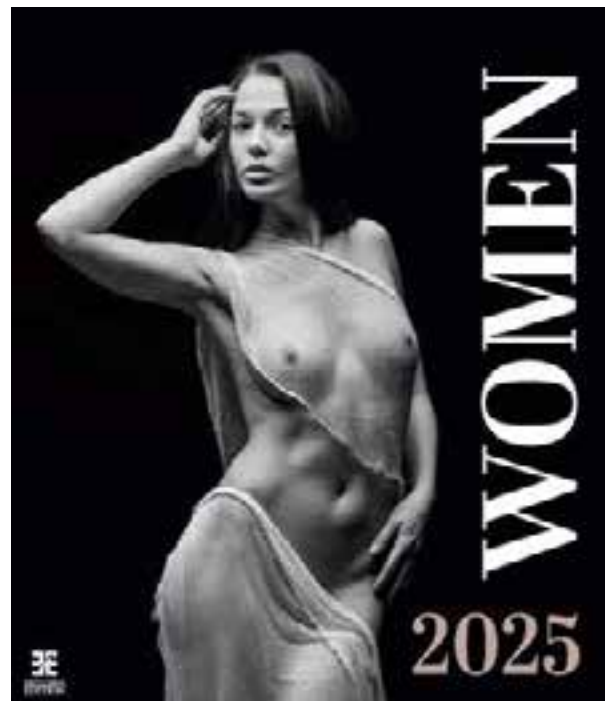

STENSKI KOLEDAR

810720

Format: 450 x 520 mm
Prostor za LOGO: 450 x 50 mm



1/10

10,90 €

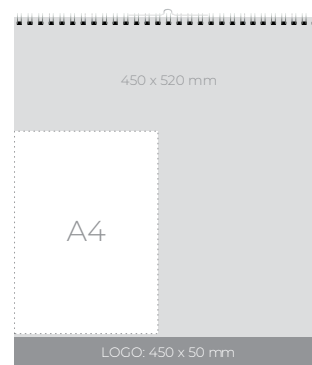

MOŠKI BARVNI



STENSKI KOLEDAR

810600

Format: 330 x 480 mm
 Prostor za LOGO: 330 x 70 mm



4,15 €



MOŠKI ČB



STENSKI KOLEDAR

810721

Format: 450 x 520 mm
 Prostor za LOGO: 450 x 50 mm



10,90 €

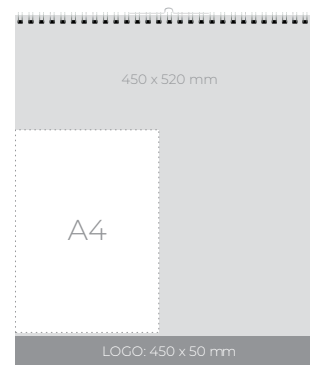

2025

January

| S | M | T | W | T | F | S |
|----|----|----|----|----|----|----|
| | | | 1 | 2 | 3 | 4 |
| 5 | 6 | 7 | 8 | 9 | 10 | 11 |
| 12 | 13 | 14 | 15 | 16 | 17 | 18 |
| 19 | 20 | 21 | 22 | 23 | 24 | 25 |
| 26 | 27 | 28 | 29 | 30 | 31 | |

February

| S | M | T | W | T | F | S |
|----|----|----|----|----|----|----|
| | | | | | | 1 |
| 2 | 3 | 4 | 5 | 6 | 7 | 8 |
| 9 | 10 | 11 | 12 | 13 | 14 | 15 |
| 16 | 17 | 18 | 19 | 20 | 21 | 22 |
| 23 | 24 | 25 | 26 | 27 | 28 | |

March

| S | M | T | W | T | F | S |
|----|----|----|----|----|----|----|
| | | | | | | 1 |
| 2 | 3 | 4 | 5 | 6 | 7 | 8 |
| 9 | 10 | 11 | 12 | 13 | 14 | 15 |
| 16 | 17 | 18 | 19 | 20 | 21 | 22 |
| 23 | 24 | 25 | 26 | 27 | 28 | 29 |
| 30 | 31 | | | | | |

April

| S | M | T | W | T | F | S |
|----|----|----|----|----|----|----|
| | | 1 | 2 | 3 | 4 | 5 |
| 6 | 7 | 8 | 9 | 10 | 11 | 12 |
| 13 | 14 | 15 | 16 | 17 | 18 | 19 |
| 20 | 21 | 22 | 23 | 24 | 25 | 26 |
| 27 | 28 | 29 | 30 | | | |

May

| S | M | T | W | T | F | S |
|----|----|----|----|----|----|----|
| | | | | 1 | 2 | 3 |
| 4 | 5 | 6 | 7 | 8 | 9 | 10 |
| 11 | 12 | 13 | 14 | 15 | 16 | 17 |
| 18 | 19 | 20 | 21 | 22 | 23 | 24 |
| 25 | 26 | 27 | 28 | 29 | 30 | 31 |

June

| S | M | T | W | T | F | S |
|----|----|----|----|----|----|----|
| 1 | 2 | 3 | 4 | 5 | 6 | 7 |
| 8 | 9 | 10 | 11 | 12 | 13 | 14 |
| 15 | 16 | 17 | 18 | 19 | 20 | 21 |
| 22 | 23 | 24 | 25 | 26 | 27 | 28 |
| 29 | 30 | | | | | |

July

| S | M | T | W | T | F | S |
|----|----|----|----|----|----|----|
| | | 1 | 2 | 3 | 4 | 5 |
| 6 | 7 | 8 | 9 | 10 | 11 | 12 |
| 13 | 14 | 15 | 16 | 17 | 18 | 19 |
| 20 | 21 | 22 | 23 | 24 | 25 | 26 |
| 27 | 28 | 29 | 30 | 31 | | |

August

| S | M | T | W | T | F | S |
|----|----|----|----|----|----|----|
| | | | | | 1 | 2 |
| 3 | 4 | 5 | 6 | 7 | 8 | 9 |
| 10 | 11 | 12 | 13 | 14 | 15 | 16 |
| 17 | 18 | 19 | 20 | 21 | 22 | 23 |
| 24 | 25 | 26 | 27 | 28 | 29 | 30 |
| 31 | | | | | | |

September

| S | M | T | W | T | F | S |
|----|----|----|----|----|----|----|
| | 1 | 2 | 3 | 4 | 5 | 6 |
| 7 | 8 | 9 | 10 | 11 | 12 | 13 |
| 14 | 15 | 16 | 17 | 18 | 19 | 20 |
| 21 | 22 | 23 | 24 | 25 | 26 | 27 |
| 28 | 29 | 30 | | | | |

October

| S | M | T | W | T | F | S |
|----|----|----|----|----|----|----|
| | | | 1 | 2 | 3 | 4 |
| 5 | 6 | 7 | 8 | 9 | 10 | 11 |
| 12 | 13 | 14 | 15 | 16 | 17 | 18 |
| 19 | 20 | 21 | 22 | 23 | 24 | 25 |
| 26 | 27 | 28 | 29 | 30 | 31 | |

November

| S | M | T | W | T | F | S |
|----|----|----|----|----|----|----|
| | | | | | | 1 |
| 2 | 3 | 4 | 5 | 6 | 7 | 8 |
| 9 | 10 | 11 | 12 | 13 | 14 | 15 |
| 16 | 17 | 18 | 19 | 20 | 21 | 22 |
| 23 | 24 | 25 | 26 | 27 | 28 | 29 |
| 30 | | | | | | |

December

| S | M | T | W | T | F | S |
|----|----|----|----|----|----|----|
| | 1 | 2 | 3 | 4 | 5 | 6 |
| 7 | 8 | 9 | 10 | 11 | 12 | 13 |
| 14 | 15 | 16 | 17 | 18 | 19 | 20 |
| 21 | 22 | 23 | 24 | 25 | 26 | 27 |
| 28 | 29 | 30 | 31 | | | |

KLASIK

Namizni koledarji, rokovniki, etuiji



T: 08 385 04 84
08 385 04 81

M: 040 861 890

E: info@partnergraf.si
prodaja@partnergraf.si

W: www.partnergraf.si

PARTNER GRAF zelena tiskarna d.o.o.
Gasilska cesta 3, SI - 1290 Grosuplje

Namizni koledar – **Piramida**



Prostor za dotisk: 100 x 20 mm

EAN koda: **3831036701527**

Šifra izdelka: **152**

Cena: **3,08 €** + 22 % DDV



- Prazniki (SLO, A, CRO, SRB, D, H, I, F)
- Lunine mene po urah
- Horoskop
- Premik ure
- Oznaka tedna
- Tekoči mesec
- Imena in godovi



bel

bordo

temno moder

limeta zelen

temno zelen

svetlo siv

temno siv

Namizni koledar – **IVO kartonski podstavek, fiksna stena**

EAN koda: **3831036701763**

Šifra izdelka: **176**

Cena: **3,88 €** + 22 % DDV

- Prazniki (SLO, A, CRO, SRB, D, H, I, F)
- Lunine mene po urah
- Horoskop
- Premik ure
- Oznaka tedna
- Imena in godovi
- Letni koledar

Prostor za dotisk: 290 x 20 mm in
40 x 290 mm

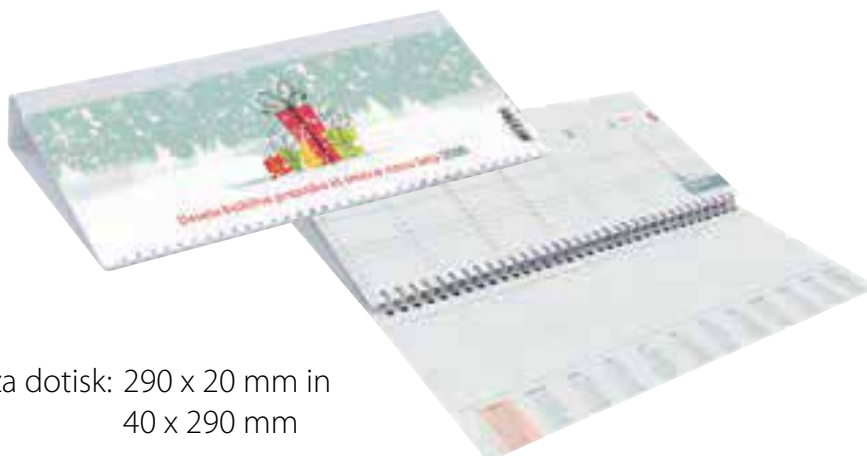

Namizni koledar – IVO mali



Prostor za dotisk:
205 x 50 mm in 205 x 20 mm

EAN koda: **3831036700520**

Šifra izdelka: **52**

Cena: **4,88 €** + 22 % DDV



- Prazniki (SLO, A, CRO, SRB, D, H, I, F)
- Lunine mene po urah
- Horoskop
- Premik ure
- Oznaka tedna
- Tekoči mesec
- Imena in godovi

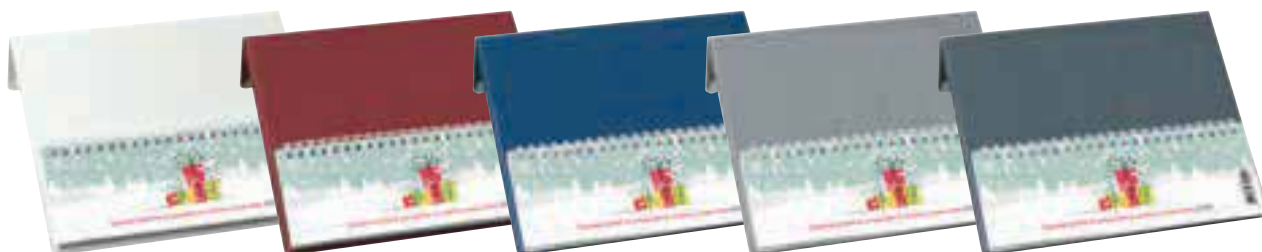

bel

bordo

temno moder

svetlo siv

temno siv

Vložek za koledar IVO mali

EAN koda: **3831036700568**

Šifra izdelka: **56**

Cena: **2,58 €** + 22 % DDV

- Prazniki (SLO, A, CRO, SRB, D, H, I, F)
- Lunine mene po urah
- Horoskop
- Premik ure
- Oznaka tedna
- Tekoči mesec
- Imena in godovi



Možnost dotiska vašega logotipa na vse izdelke.

Namizni koledar – **PLEXI IVO mali**



Prostor za dotisk:
205 x 25 mm, 205 x 50 mm

EAN koda: **3831036708106**

Šifra izdelka: **810**

Cena: **6,88 €** + 22 % DDV



- Prazniki (SLO, A, CRO, SRB, D, H, I, F)
- Lunine mene po urah
- Horoskop
- Premik ure
- Oznaka tedna
- Tekoči mesec
- Imena in godovi

Vložek za koledar IVO mali

EAN koda: **3831036700568**

Šifra izdelka: **56**

Cena: **2,58 €** + 22 % DDV

- Prazniki (SLO, A, CRO, SRB, D, H, I, F)
- Lunine mene po urah
- Horoskop
- Premik ure
- Oznaka tedna
- Tekoči mesec
- Imena in godovi



Namizni koledar – PLEXI tedenski kot knjiga



Prostor za dotisk: 205 x 25 mm

EAN koda: **3831036702739**

Šifra izdelka: **273**

Cena: **5,20 €** + 22 % DDV



- Prazniki (SLO, A, CRO, SRB, D, H, I, F)
- Lunine mene po urah
- Horoskop
- Premik ure
- Oznaka tedna
- Tekoči mesec
- Imena in godovi

Vložek za koledar PLEXI – tedenski

EAN koda: **3831036701879**

Šifra izdelka: **187**

Cena: **1,38 €** + 22 % DDV

- Prazniki (SLO, A, CRO, SRB, D, H, I, F)
- Lunine mene po urah
- Horoskop
- Premik ure
- Oznaka tedna
- Tekoči mesec
- Imena in godovi



Možnost dotiska vašega logotipa na vse izdelke.

Namizni koledar – **PVC tedenski kot knjiga**



Prostor za dotisk:
205 x 30 mm in 205 x 50 mm

EAN koda: **3831036708298**

Šifra izdelka: **829**

Cena: **4,88 €** + 22 % DDV

- Prazniki (SLO, A, CRO, SRB, D, H, I, F)
- Lunine mene po urah
- Horoskop
- Premik ure
- Oznaka tedna
- Tekoči mesec
- Imena in godovi



bel

bordo

temno moder

svetlo siv

temno siv

Vložek za koledar PLEXI – tedenski

EAN koda: **3831036701879**

Šifra izdelka: **187**

Cena: **1,38 €** + 22 % DDV

- Prazniki (SLO, A, CRO, SRB, D, H, I, F)
- Lunine mene po urah
- Horoskop
- Premik ure
- Oznaka tedna
- Tekoči mesec
- Imena in godovi



Namizni koledar – PVC 14-dnevni kot knjiga



Prostor za dotisk:
205 x 30 mm in 205 x 50 mm

EAN koda: **3831036708489**

Šifra izdelka: **848**

Cena: **5,88 €** + 22 % DDV

- Prazniki (SLO, A, CRO, SRB, D, H, I, F)
- Lunine mene po urah
- Horoskop
- Premik ure
- Oznaka tedna
- Imena in godovi



bel

bordo

temno moder

svetlo siv

temno siv

Vložek za koledar PVC – 14-dnevni

EAN koda: **3831036704603**

Šifra izdelka: **460**

Cena: **2,88 €** + 22 % DDV

- Prazniki (SLO, A, CRO, SRB, D, H, I, F)
- Lunine mene po urah
- Horoskop
- Premik ure
- Oznaka tedna
- Imena in godovi



Možnost dotiska vašega logotipa na vse izdelke.

Namizni koledar – IVO



Prostor za dotisk: 290 x 60 mm

EAN koda: **3831036701411**

Šifra izdelka: **141**

Cena: **5,80 €** + 22 % DDV

- Prazniki (SLO, A, CRO, SRB, D, H, I, F)
- Lunine mene po urah
- Horoskop
- Premik ure
- Oznaka tedna
- Imena in godovi
- Letni koledar



bel

bordo

temno moder

svetlo siv

temno siv

Vložek za koledar IVO

EAN koda: **3831036703774**

Šifra izdelka: **377**

Cena: **2,88 €** + 22 % DDV

- Prazniki (SLO, A, CRO, SRB, D, H, I, F)
- Lunine mene po urah
- Horoskop
- Premik ure
- Oznaka tedna
- Imena in godovi
- Letni koledar



Koledar **Setveni**



Prostor za dotisk: 230 x 50 mm

Format: 23 x 33 cm

Špiralna vezava

13 listni

EAN koda: **3831036708304**

Šifra izdelka: **830**

Cena: **1,18 €** + 22 % DDV

Podatki so iz Setvenega priročnika Marije Thun za leto 2025.

Stenski koledar **Tito**



Prostor za dotisk: 310 x 60 mm

Format: 31 x 50 cm

Špiralna vezava

13 listni

Natron vrečka

• Prazniki (SLO)

EAN koda: **3831036701534**

Šifra izdelka: **153**

Cena: **5,90 €** + 22 % DDV



Možnost dotiska vašega logotipa na vse izdelke.

Poslovník **STORŽ**

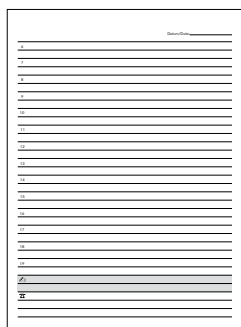

- Format: 20 x 27 cm
- Mesečni planer
 - Koledar za štiri leta
 - 192 strani, s črtami
 - Državni prazniki v SLO in EU
 - Osebni podatki

EAN koda: **3831036707963**

Šifra izdelka: **796**

Cena: **7,28 €** + 22 % DDV

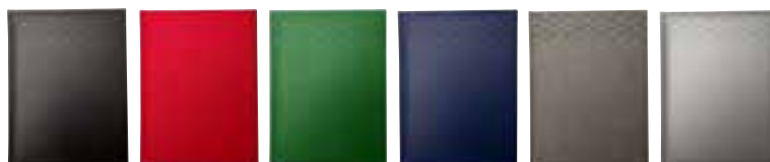

črna

rdeča

zelena

modra

bež

srebrna

Rokovnik **METALIC**



Format: 20 x 27 cm

Šivan po robovih

- Mesečni planer
- Koledar
- Razdalje med slovenskimi kraji
- Pretvornik mer – pretvorni faktorji
- 224 strani z urami od 6. do 19. ure

EAN koda: **3831036712370**

Šifra izdelka: **1237**

Cena: **7,18 €** + 22 % DDV



svetlo modra

črna

Rokovnik **ROYAL**



Format: 20 x 26 cm

- Mesečni planer
- Koledar do 2026
- Razdalje med slovenskimi kraji
- Razdalje med glavnimi evropskimi mesti
- Državni prazniki, SLO in EU
- Pretvornik mer – pretvorni faktorji
- 224 strani z urami od 7. do 19. ure

EAN koda: **3831036712714**

Šifra izdelka: **1271**

Cena: **6,98 €** + 22 % DDV



črna

rdeča

siva

zelena

Poslovník



EAN koda: **3831036712721**

Šifra izdelka: **1272**

Cena: **6,98 €** + 22 % DDV

Format: 20 x 26 cm

• 224 strani z urami od 7. do 19. ure



srebrna



modra

Rokovnik **DNEVNI DATUMI**



Format: 16 x 24 cm

**Vsak dan na svojem listu,
tudi nedelja.**



EAN koda: **3830013291631**

Šifra izdelka: **801**

Cena: **12,98 €** + 22 % DDV



temno moder



temno rdeč



temno zelen



črn



svetlo siv

Rokovnik **DNEVNIK z DATUMI B5**



Format: 17,2 x 24,3 cm

Barva: temno modra

**Vsak dan na svojem listu,
tudi nedelja.**

EAN koda: **3831036702715**

Šifra izdelka: **271**

Cena: **11,38 €** + 22 % DDV



Možnost dotiska vašega logotipa na vse izdelke.

Rokovnik **TEDENSKI DATUMI**



Format: 20 x 26 cm, 224 strani

Notranjost:

1/2 tedenski datumi

1/2 beležke



EAN koda: **3831036704542**

Šifra izdelka: **454**

Cena: **12,80 €** + 22 % DDV



modra

oranžna

rdeča

siva

zelena

Planer **EKO**

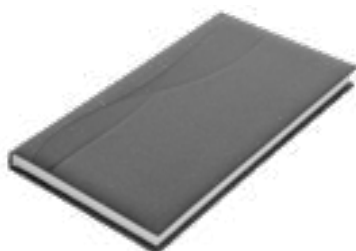

Format: 8,5 x 15 cm, 128 strani

Notranjost: tedenski planer

EAN koda: **3831036706485**

Šifra izdelka: **648**

Cena: **5,80 €** + 22 % DDV

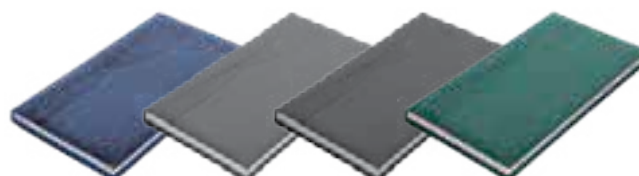

modra

svetlo siva

temo siva

zelena

Planer **CLASSIC**



Format: 8,5 x 15 cm, 128 strani

Notranjost: tedenski planer

EAN koda: **3831036706485**

Šifra izdelka: **648**

Cena: **5,80 €** + 22 % DDV



bordo

črna

modra

rdeča

zelena

Namizna podloga s pasico

Prostor za dotisk: 500 x 30 mm

EAN koda: **3831036706713**

Šifra izdelka: **671**

Cena: **5,88 €** + 22 % DDV



Barve: ● bordo, ● temno modra, ● temno siva, ● svetlo siva, ● bela, ● temno zelena

Možna izdelava pasice po naročilu,
širina **49,5 cm, 54 cm, 58 cm, 60 cm, 64 cm**.
Za ceno pošljite povpraševanje.

Podloga z vizitkarjem za 120 vizitk

Prostor za dotisk: 500 x 30 mm

EAN koda: **3831036790903**

Šifra izdelka: **9090**

Cena: **17,80 €** + 22 % DDV

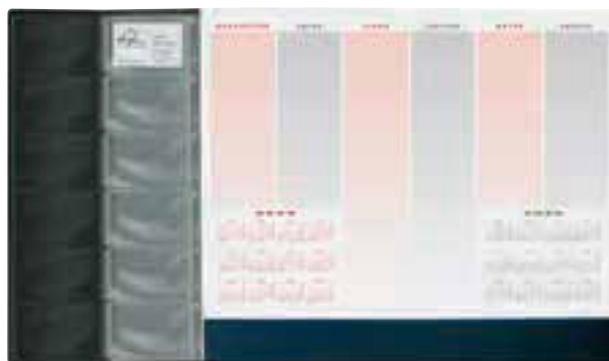

Barve: ● bordo, ● temno modra

Namizna kocka **MINI EURO PALETA**



Format kocke: 120 x 80 x 16 mm, 500 listni blok
Prostor za dotisk: 100 x 40 mm in 60 x 40 mm

Kocka je vakumsko pakirana.

EAN koda: **3831036710239**

Šifra izdelka: **1023**

Cena: **5,38 €** + 22 % DDV

MINI EURO PALETA



Format palete: 120 x 80 x 16 mm

EAN koda: **3831036710246**

Šifra izdelka: **1024**

Cena: **2,80 €** + 22 % DDV

Možnost dotiska vašega logotipa na vse izdelke.

Koledar – **Kocka**



EAN koda: **3831036701435**

Šifra izdelka: **143**

Cena: **1,48 €** + 22 % DDV

OKENČKI za koledarje

50 x 34 mm
40 x 26 mm
Šifra: 190

38 x 28 mm
30 x 20 mm
Šifra: 92



Okenčki na traku za označevanje dnevov pri večmesečnih koledarjih. Ni potrebno izsekovanje koledarskega dela.

Izdelajo se po naročilu, glede na širino koledarja.

Barve: ● rdeča, ● temno modra,
● rumena, ● zelena

Šifra izdelka: **190** in **92**

Cena: **0,58 €** + 22 % DDV

Minimalna količina pakiranja 100 kos.

Skladiščna podloga enojna



Prostor za dotisk: A4 (210 x 297 mm)

EAN koda: **3831036700179**

Šifra izdelka: **17**

Cena: **3,68 €** + 22 % DDV

ZATIČI za koledarje



48 x 31 mm
38 x 21 mm
Šifra: 126



40 x 27 mm
29 x 16 mm
Šifra: 90



41 x 25 mm
34 x 17 mm
Šifra: 125



33 x 20 mm
25 x 13 mm
Šifra: 261

Zatič za označevanje dnevov pri večmesečnih koledarjih.

Barve:

- rdeča,
- temno modra,
- rumena,
- temno zelena,
- bordo

Šifra izdelka: **126, 90, 125, 261**

Cena: **0,08 €** + 22 % DDV

Minimalna količina pakiranja 1000 kos.

Skladiščna podloga dvojna



Prostor za dotisk: A4 (210 x 297 mm)

EAN koda: **3831036704146**

Šifra izdelka: **414**

Cena: **5,18 €** + 22 % DDV

Vizitkar mali za 72 vizitk



Prostor za dotisk: 100 x 60 mm

EAN koda: **3831036700247**

Šifra izdelka: **24**

Cena: **5,28 €** + 22 % DDV

Vizitkar veliki za 96 vizitk



Prostor za dotisk:
100 x 60 mm

EAN koda: **3831036700230**

Šifra izdelka: **23**

Cena: **6,28 €** + 22 % DDV

Adresar



Adresar žepni

Prostor za dotisk:
60 x 100 mm

EAN koda: **3831036701510**

Šifra izdelka: **151**

Cena: **3,80 €** + 22 % DDV



Adresar osebni

Prostor za dotisk:
100 x 150 mm

EAN koda: **3831036701237**

Šifra izdelka: **123**

Cena: **5,58 €** + 22 % DDV

Album za 6 kartic



Prostor za dotisk: 60 x 40 mm

EAN koda: **3831036703095**

Šifra izdelka: **309**

Cena: **2,98 €** + 22 % DDV

Barve: rdeča, bordo, temno modra,
temno zelena, črna, siva



Album za 20 kartic



Prostor za dotisk:
60 x 40 mm

EAN koda: **3831036700797**

Šifra izdelka: **79**

Cena: **6,48 €** + 22 % DDV

Barve: rdeča, bordo, temno modra,
temno zelena, črna, siva

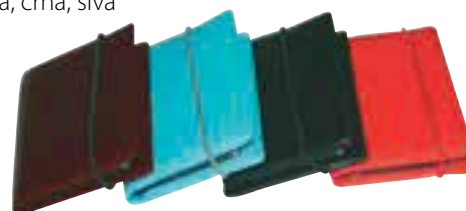

Možnost dotiska vašega logotipa na vse izdelke.



PARTNER GRAF zelena tiskarna d.o.o., Gasilska cesta 3, SI - 1290 Grosuplje

prodaja@partnergraf.si | 08 385 04 84